

ASSEMBLY INSTRUCTION

Storage Box w/Wheels, Nature, PAULOWNIA

50205305



Component List

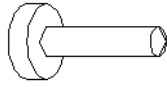

X16pcs



X2pcs



X2pcs

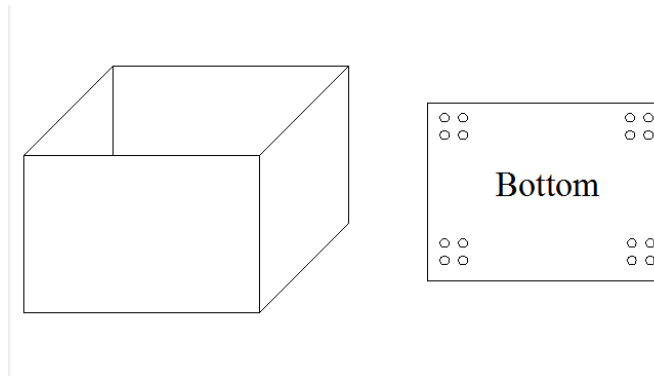

X1pc

INSTRUCTION

Step 1

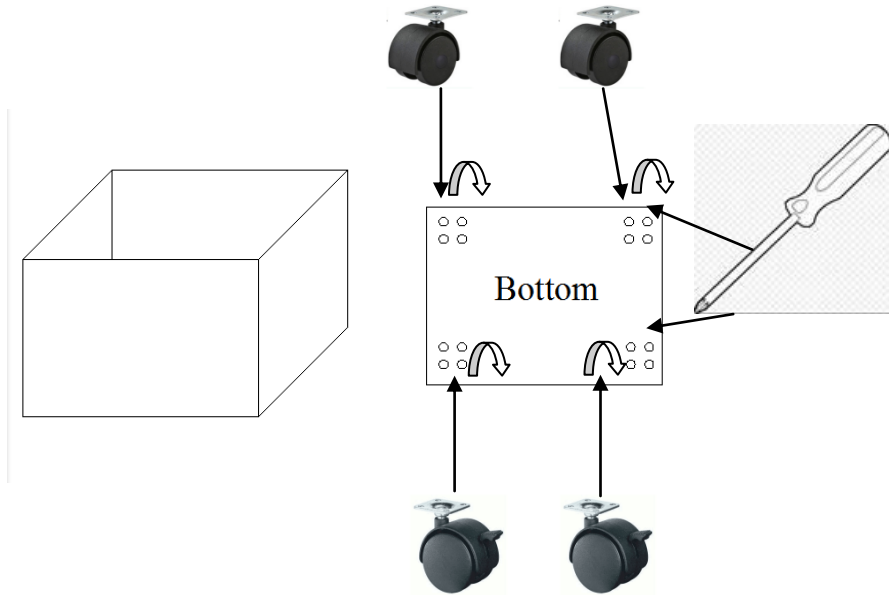

Step 2

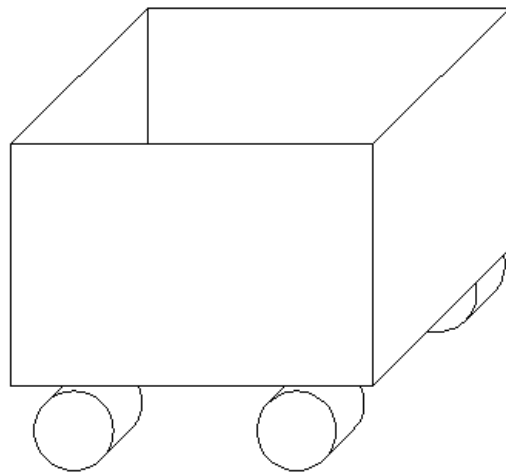

Finished



5.0kg/11.0 lbs

