

Assembly Instruction

Soft Shelf Small

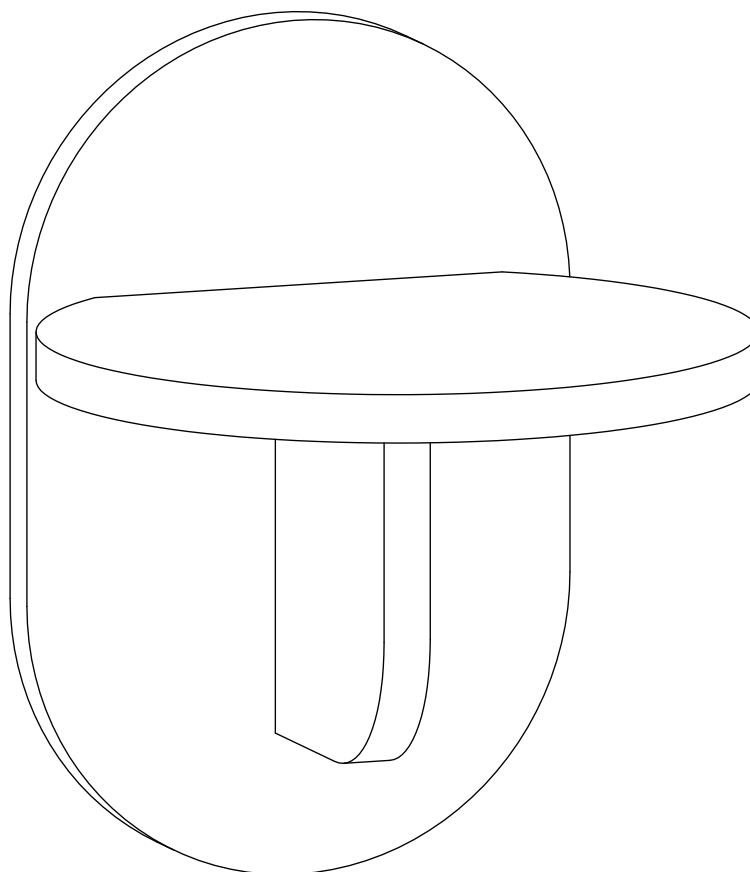

242x200x300

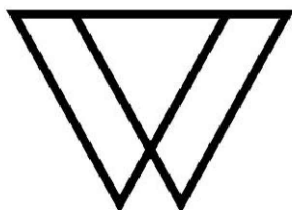

WOODMAN[®]

DESIGN FURNITURE FACTORY

Woodman OÜ

Made in Estonia

Mäo, Järvamaa

www.woodman.ee

support@woodman.ee

Dear Customer

Congratulations on your new purchase.
Follow this advice and get the best
result when assembling the product.

- Read the instruction carefully before you start
- Get help, if two persons are required for assembly
- Make sure, you have all parts on the total material list
- Work on a soft, flat surface to avoid any damage to the finish
- Follow the assembly instruction
- Tighten the furniture joints after a month
- Keep the assembly instruction

Allocate time

Some furniture can be assembled in minutes. Others – e.g. products in several parts – can take more than an hour to finish. Make sure to allocate good time or divide up the work.

If any parts are missing or if you have questions for the assembly instruction, please contact customer support at ilva.dk. Please mention item no. and reference no from page 1

Best regards,
ILVA



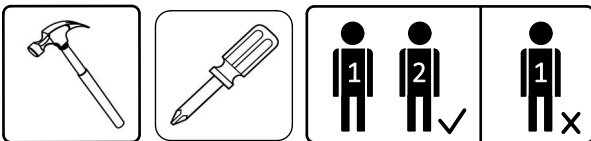

Tools needed

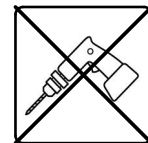

Don't use!!!

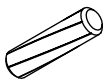

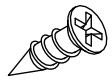
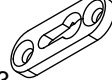
Total material list, hardware

A1 x3 8x35 	A2 x2 5x50 	A3 x4 3.5x15 	A4 x2 42x14x3 	A5 x1 3mm 
---	---	---	---	--

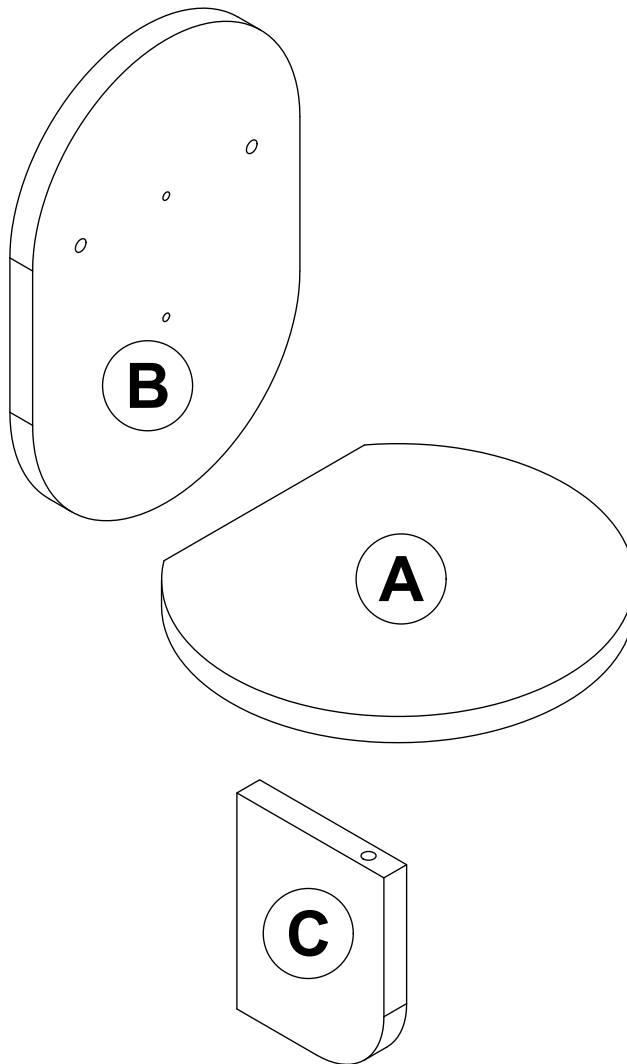

Assembly instructions, 1

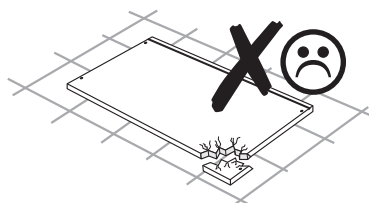
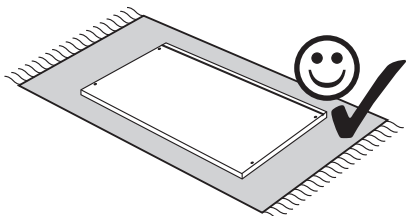
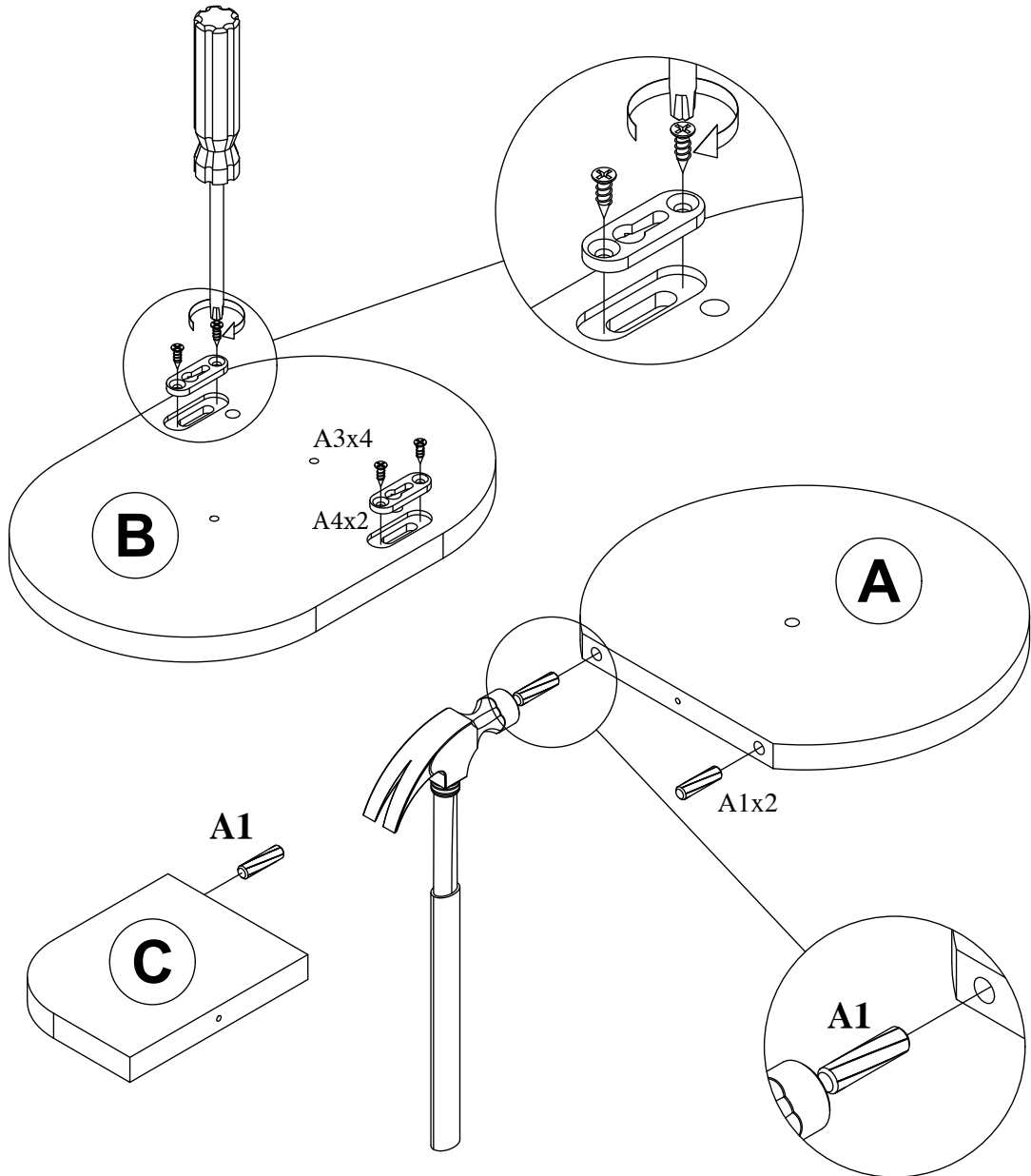
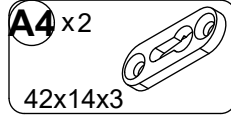
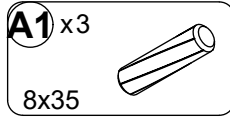
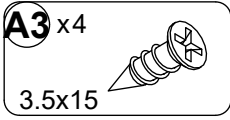

Assembly instructions, 2

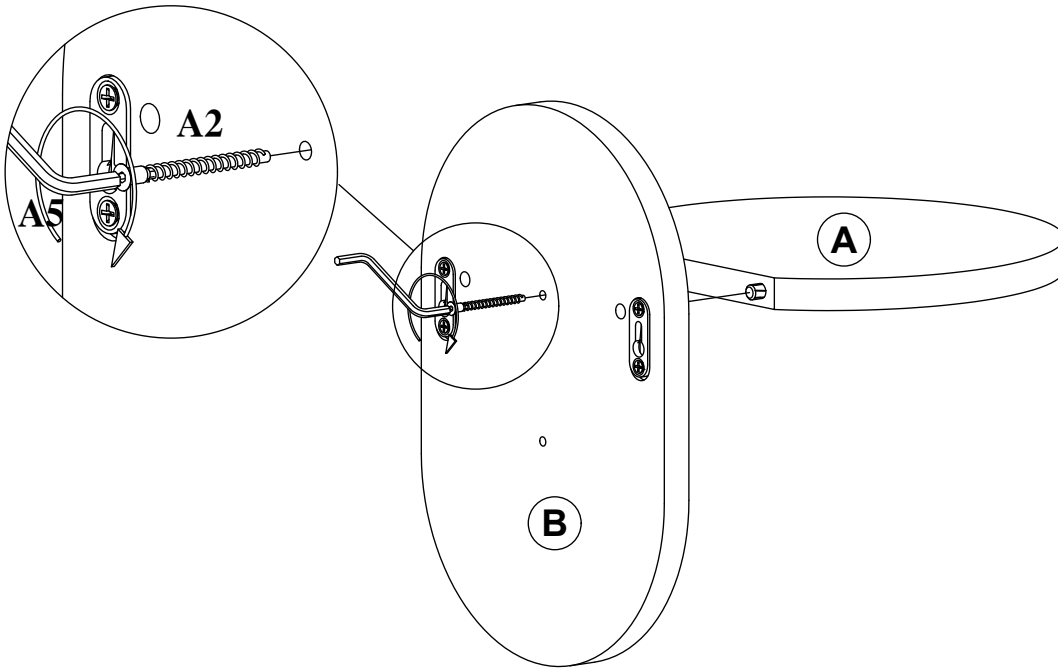
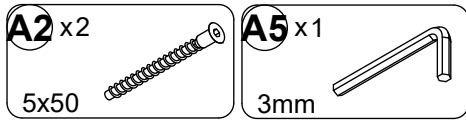

Assembly instructions, 3

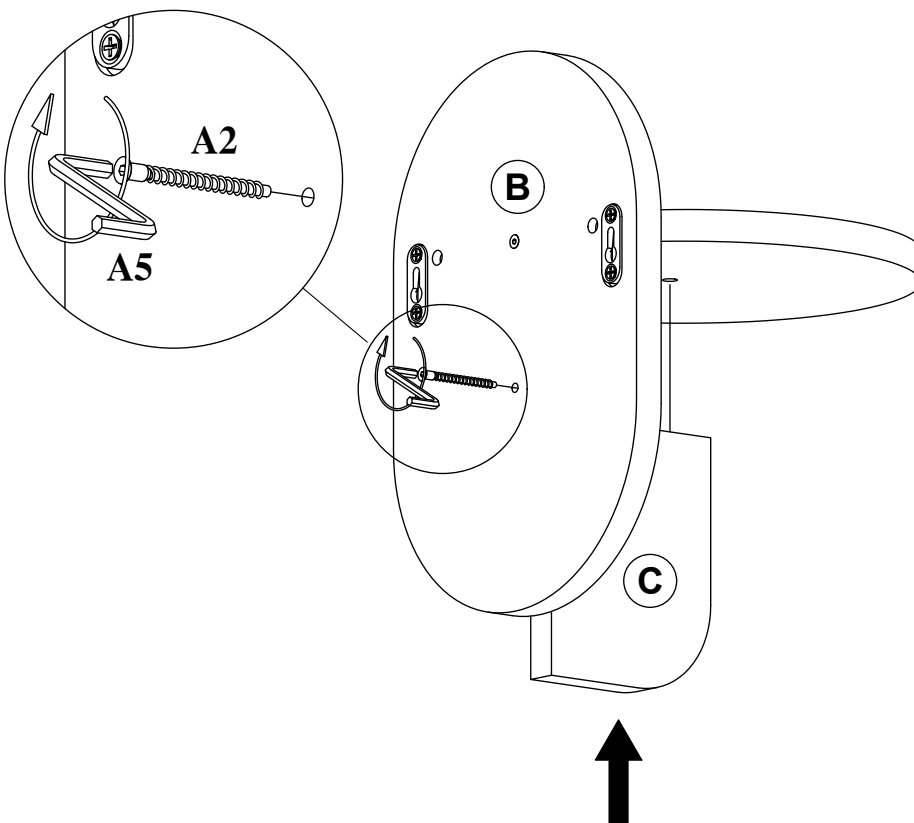

A Guide to - Wall Mounting & Fixings

Important note:

Wall Fixings:



- because of the variety of different wall types, Habitat cannot provide you with the exact fixings you will need to fix this product to the wall.

You must first identify the type of wall you intend to fix product onto and then contact your local hardware store to get the appropriate fixings.



Important: When drilling into walls always check that there are no hidden wires or pipes etc.

Make sure that the screws and wall plugs being used are suitable for supporting your unit. Consult a qualified tradesperson if you are unsure.

Hints:

- 1: General rule:**  Always use a larger screw and wall plug if you are not sure.
- 2:** Ensure you use the recommended drill bit to match the wall plug and hole size.
- 3:** Ensure you drill the hole horizontally, do not force the drill or enlarge the hole.
- 4:** Take extra care when drilling high walls, ceilings and ceramic tiles. Ensure wall plugs are inserted beyond the thickness of the ceramic tiles to avoid the tiles splitting or cracking.
- 5:** Ensure wall plugs are well fitted and are a tight fit in the drilled hole.

Types of walls

You can use one of the following types of wall plug if your walls are made of brick, breeze block, concrete, stone or wood.

No.1 "General Purpose" wall plug

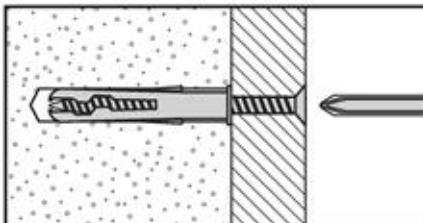

Generally aerated blocks should not be used to support heavy loads, use a specialist fitting in this case. For light loads, general purpose wall plugs can be used.

No.3 "Cavity Fixing" wall plug

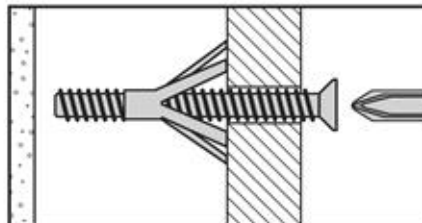

For use with plasterboard partitions or hollow wooden doors.

No.5 "Hammer Fixing" wall plug

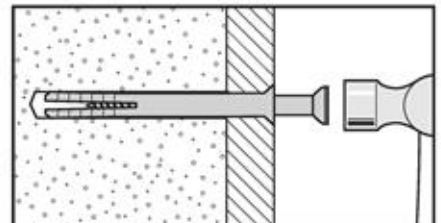

For use with walls stuck with plasterboard. The hammer fixing allows it to be fixed to the wall rather than the plasterboard. Always check the fixing is secure to the retaining wall.

No.2 "Plasterboard" wall plug

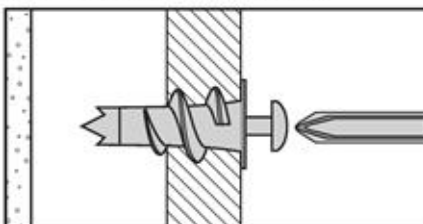

For use when attaching light loads on to plasterboard partitions.

No.4 "Cavity Fixing-Heavy Duty" wall plug

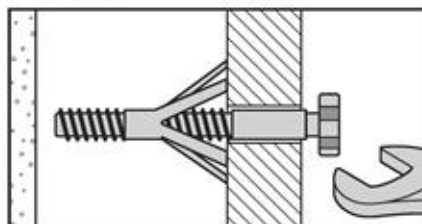

For use when fitting or supporting heavy loads such as shelving, wall cabinets and coat racks.

No.6 "Shield Anchor" wall plug Heavy loads

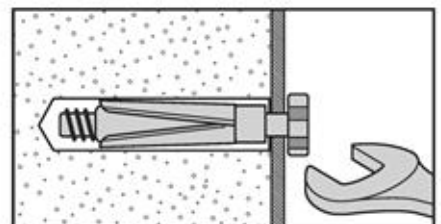

For use with heavier loads such as TV & HiFi speakers and satellite dishes etc.



Care & Maintenance

Safety: Always check the fitting and location to ensure your safety in and around the home.

Fitting: From time to time check the fitting to ensure the wall plugs or screws do not become loose.

Assembly instructions, 4

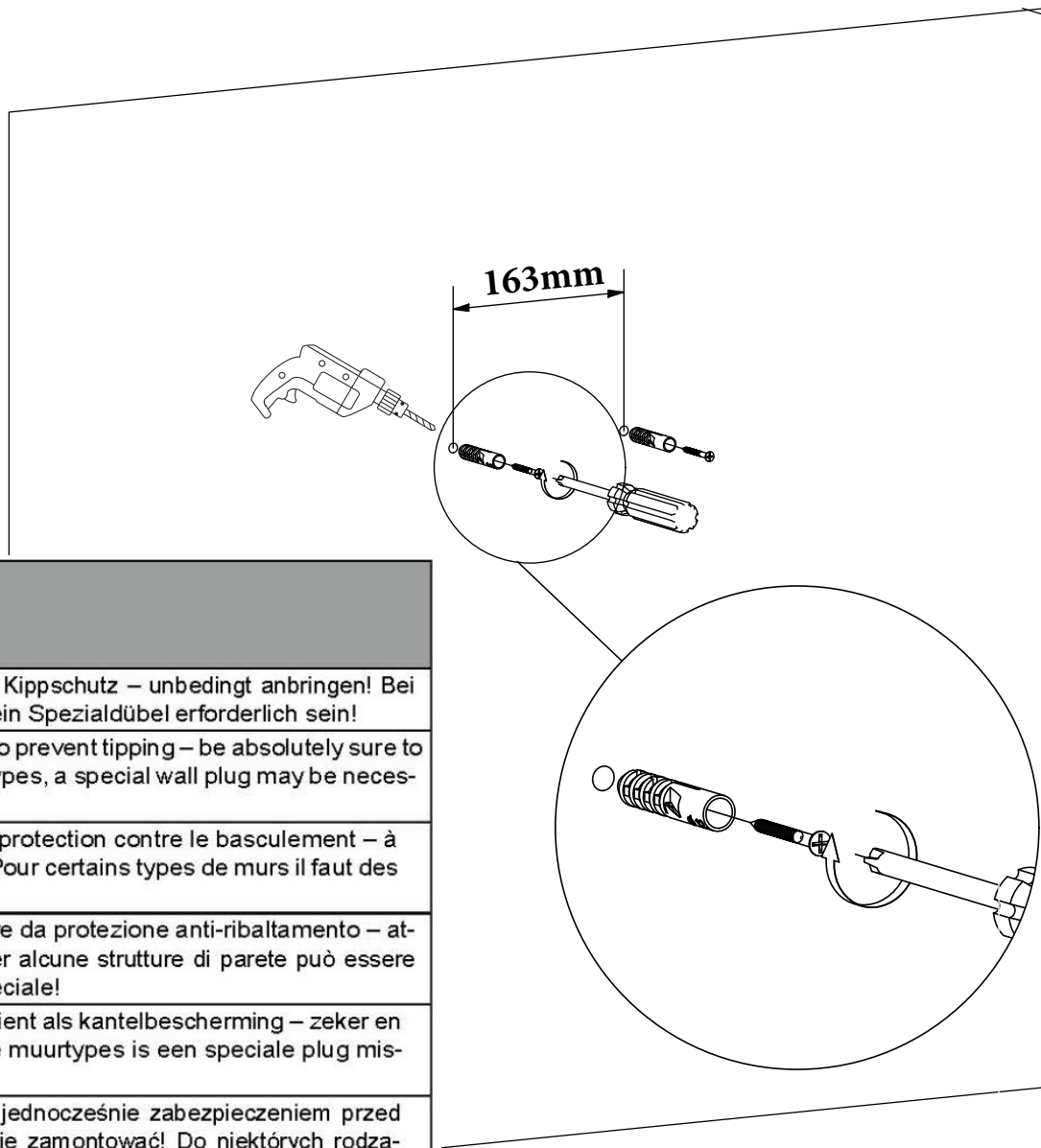

D	Wandbefestigung dient als Kippschutz – unbedingt anbringen! Bei einigen Wandtypen kann ein Spezialdübel erforderlich sein!
GB	The wall fastening serves to prevent tipping – be absolutely sure to mount it! For certain wall types, a special wall plug may be necessary!
FR	La fixation murale sert de protection contre le basculement – à installer impérativement ! Pour certains types de murs il faut des chevilles spéciales !
IT	Il fissaggio alla parete serve da protezione anti-ribaltamento – attaccarla assolutamente! Per alcune strutture di parete può essere necessario un tassello speciale!
NL	Bevestiging aan de muur dient als kantelbescherming – zeker en vast bevestigen! Bij enkele muurtypes is een speciale plug misschien vereist!
PL	Mocowanie do ściany jest jednocześnie zabezpieczeniem przed przewróceniem – koniecznie zamontować! Do niektórych rodzajów ścian koniecznie zastosować specjalne kołki mocujące.
CZ	Montáž na stěnu slouží jako ochrana proti převrnutí – bezpodmínečně umístěte! U některých typů stěn může být zapotřebí speciální hmoždinka!
SK	Upevnenie na stenu slúži ako ochrana proti prevráteniu – bezpodmienečne použite! Pre niektoré druhy stien môže byť potrebná špeciálna hmoždinka!
HU	A terméket a falhoz kel rögzíteni, különben az felborulhat! Egyes faltípusoknál speciális tiplőt kell használni!
RO	Sistemul de fixare la perete servește ca protecție la răsturnare – de montat obligatoriu! Pentru unele tipuri de pereți este posibil să fie necesar un diblu special!
TR	Duvardaki sabitleme, devrilmeye karşı bir emniyet tedbiridir ve mutlaka monte edilmelidir! Bazı duvar tiplerinde bunun için özel bir dübel gerekli olabilir!
RU	Обязательно установите крепление на стене во избежание опрокидывания! Для некоторых типов стен может потребоваться специальный дюбель!

Assembly instructions, 5

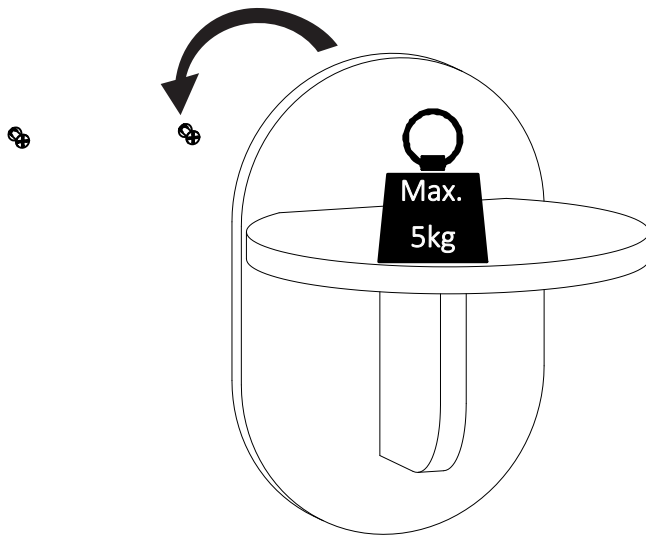

Safety and Care Advice

General care and maintenance

Only clean using a damp cloth and mild detergent, do not use bleach or abrasive cleaners.

From time to time check that there are no loose screws on this unit.

This product should not be discarded with household waste. Take to your local authority waste disposal centre.

Cleaning and care of lacquered surfaces

Regular dusting with a dry cloth will keep your units clean.

Clean marks with a damp cloth.

Do not use abrasive cleaners.

Do not clean with products containing following:

Acetone (e.g. nail varnish remover). Ammonia (e.g. bleach) or Sodium hydroxid (e.g. Caustic soda, drain and oven cleaners) .

To remove stubborn stain, wipe over with damp cloth and washing up liquid.

In the event of accidental contact with aggressive cleaners, rinse thoroughly with water. Use place mats to protect the surface from moisture and heat.

Maximum weight limit

Important: Recommended maximum load for each shelf is shown below.