

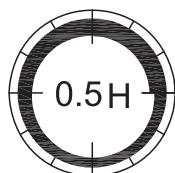

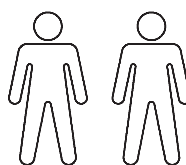

STRINGTON

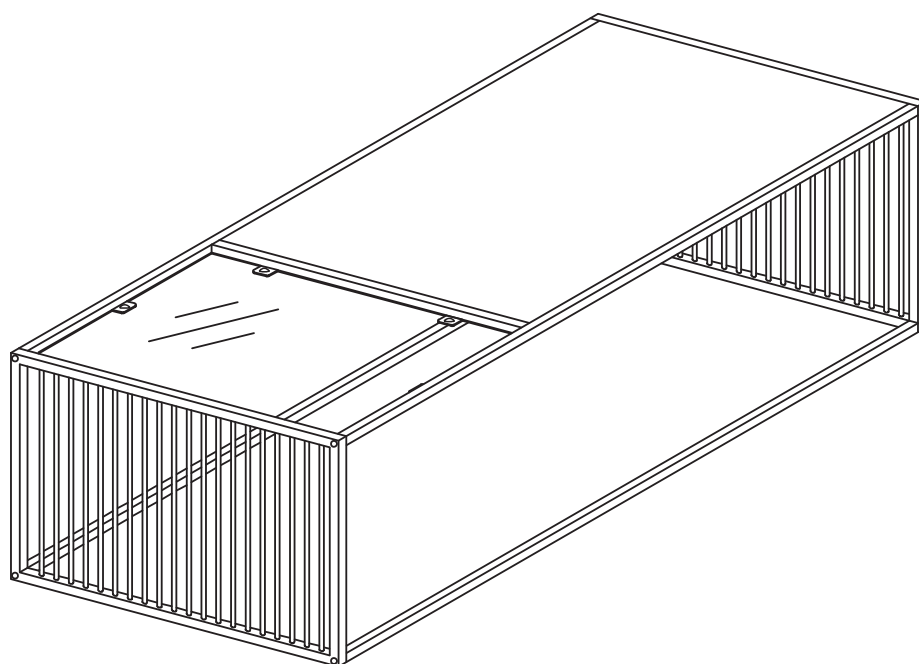
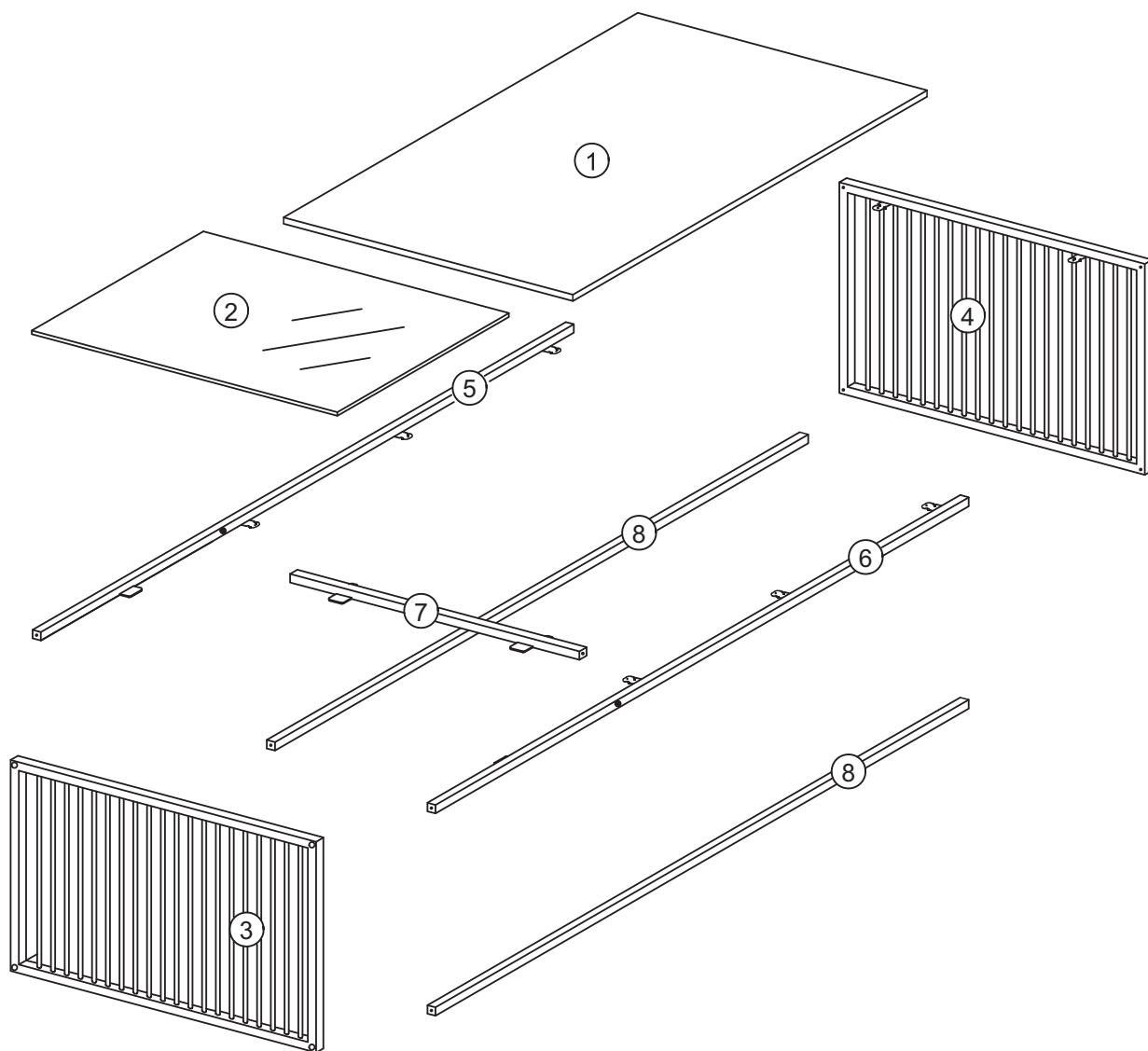
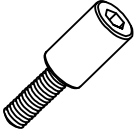

			✓
①	1	775x567x12	
②	1	567x375x5	
③	1	600x400x26/16	
④	1	600x400x42/16	
⑤	1	1168x42x16	
⑥	1	1168x42x16	
⑦	1	568x52x16	
⑧	2	1168x16x16	

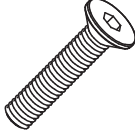

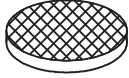
<p>A x 8</p>  <p>M6x15mm</p>	<p>B x 10</p>  <p>Ø4 x12mm</p>	<p>C x 2</p>  <p>M6x35 mm</p>	<p>D x 1</p>  <p>4mm</p>
<p>Ex 6</p>  <p>Ø8x1 mm</p>	<p>F x 6</p>  <p>Ø15x3 mm</p>		

1

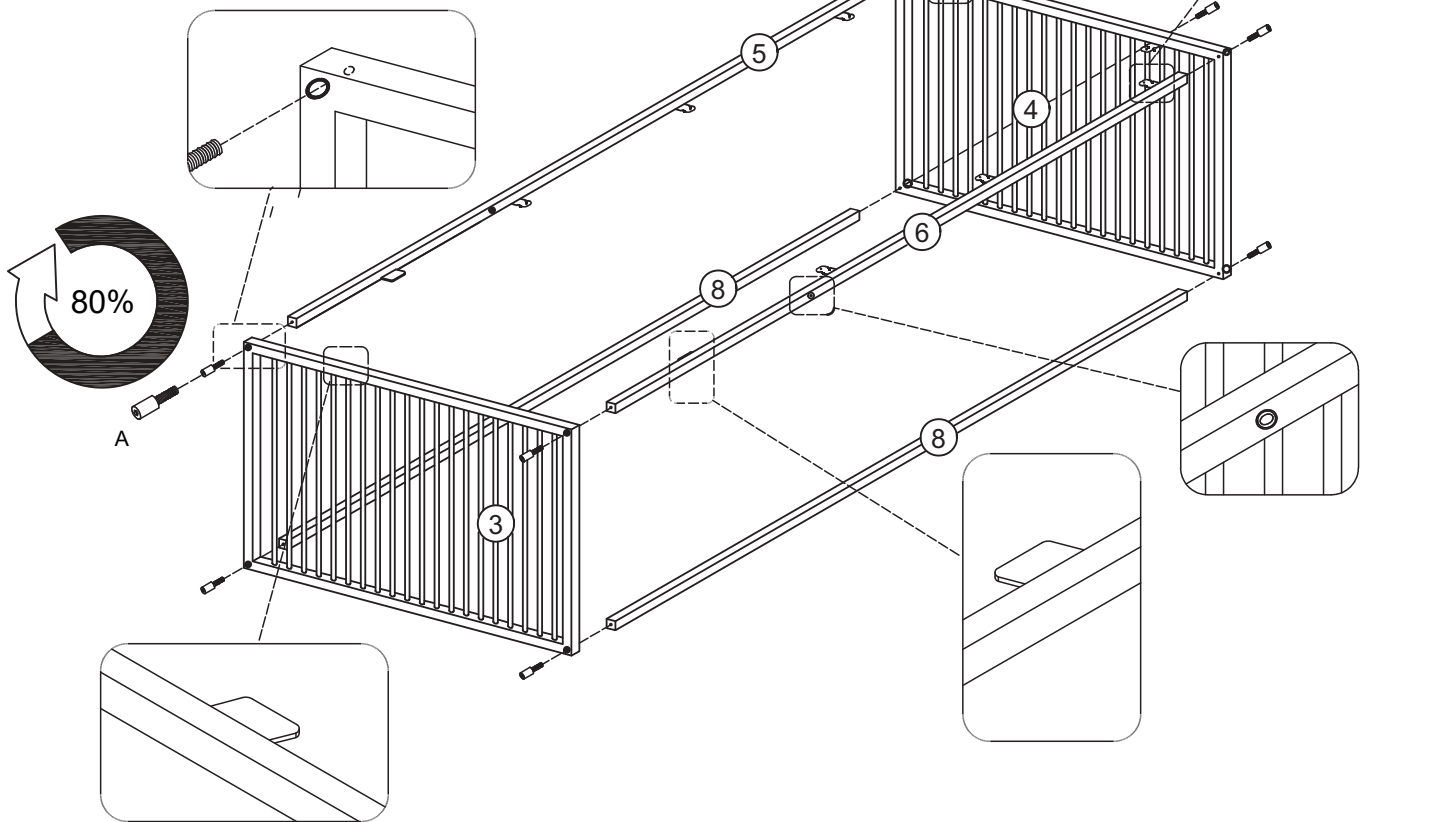
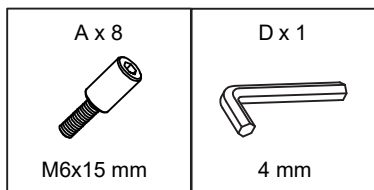

2

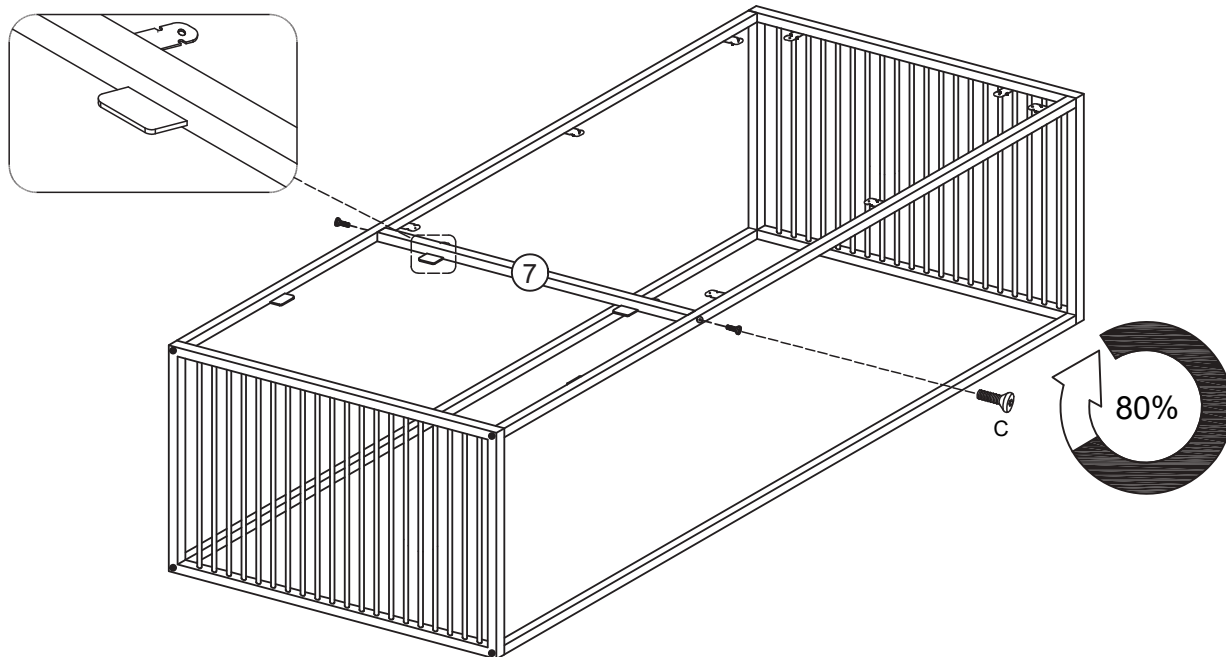
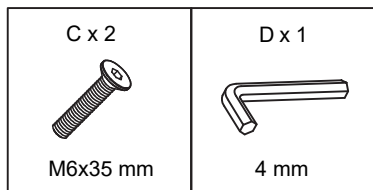

3

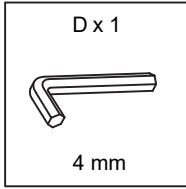

XX=YY

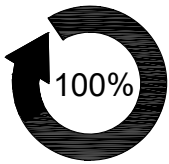
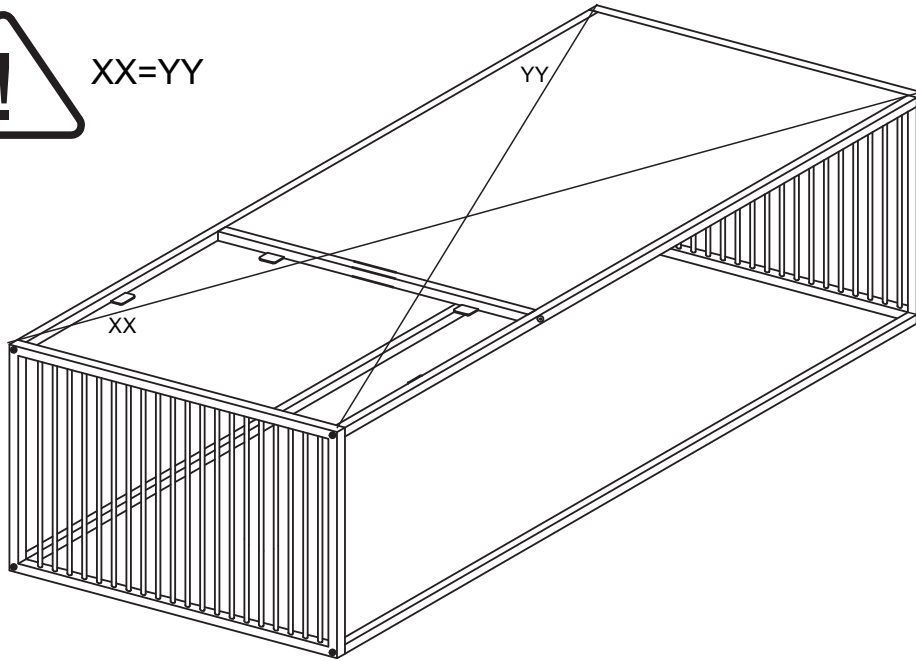

Ax8
Cx2

4

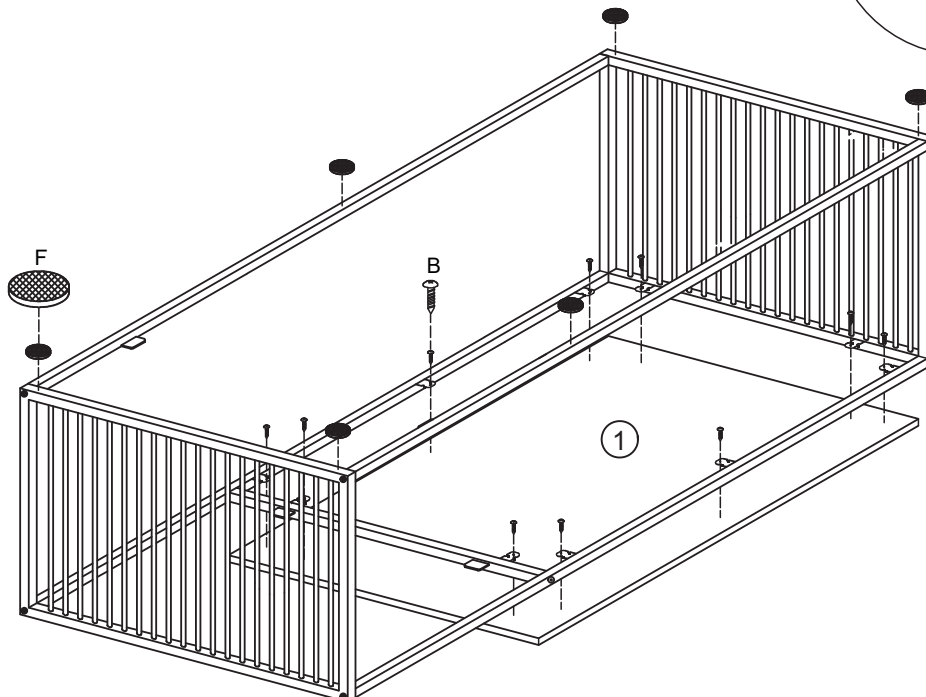
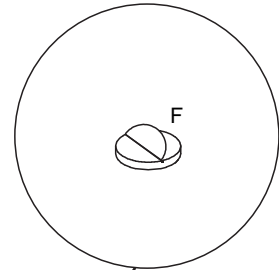
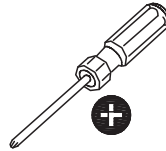
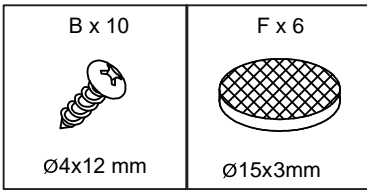

5

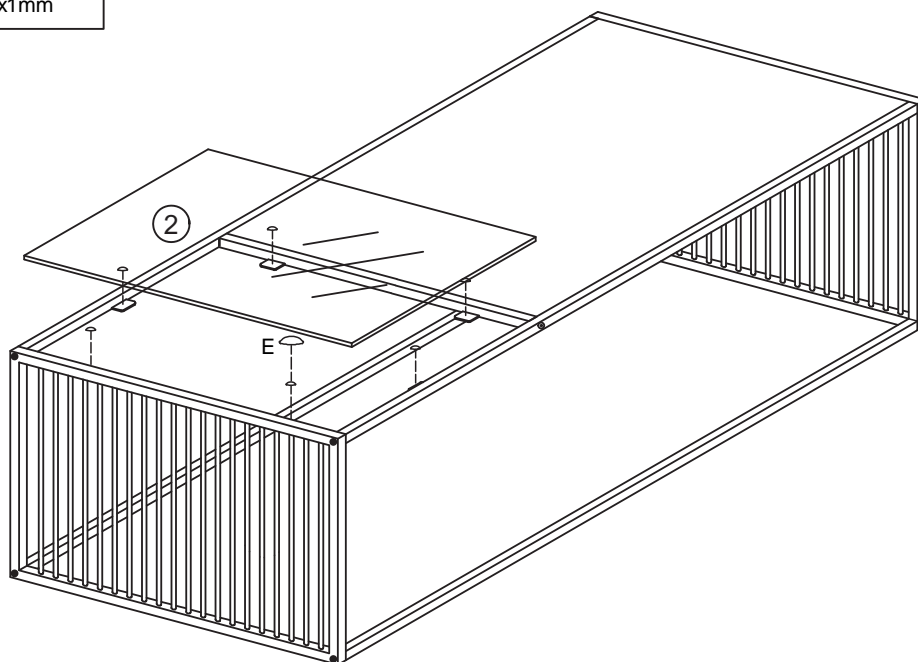
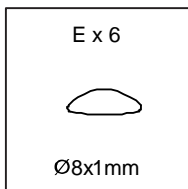

6

