

BUNKBED 90X200

FOSB9012

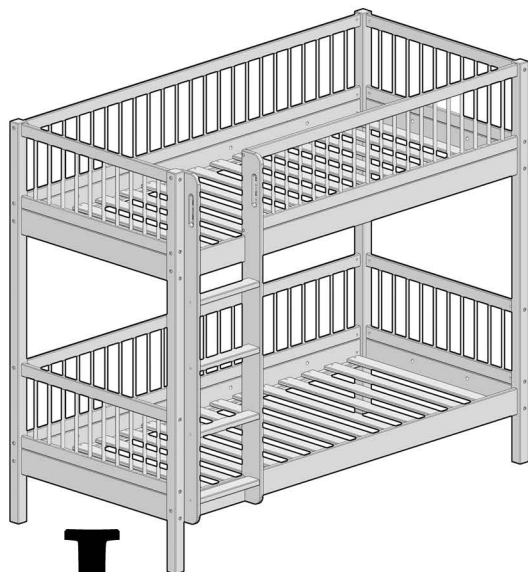

I



II

- | | |
|---------------------------------------|-----------------------------------|
| D Montageanleitung | GB Assembly instructions |
| NL Handleiding voor de montage | PL Instrukcja montażu |
| TR Montaj talimatı | RU ИHcTpyкция По MoHTажy |
| FR Notice de montage | IT Istruzioni di montaggio |
| CS Montážní návod | SK Návod na montáž |
| HU Szerelési útmutató | RO Instrucțiuni de montaj |

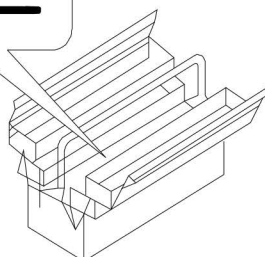
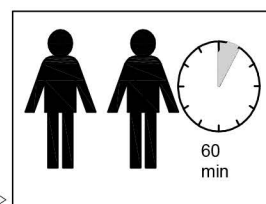
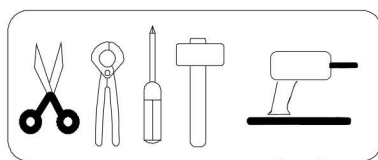
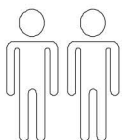

F Instructions d'utilisation

IMPORTANT - LIRE ATTENTIVEMENT - A CONSERVER POUR REFERENCE ULTERIEURE

1. Utiliser les outils indiqués sur la notice de montage et suivre les instructions d'assemblage. Utilisez toujours le mode d'emploi du fabricant
2. Il convient que tous les dispositifs d'assemblage soient toujours convenablement serrés et régulièrement vérifiés, ainsi que resserrés si nécessaire.
3. Le positionnement et le moyen d'accès au lit sont indiqués sur la notice de montage.
4. **Respecter l'épaisseur maximale du matelas, voir le marquage sur l'étiquette collé sur le lit.**
5. Taille du matelas recommandé 2000 x 900 maximum. **L'épaisseur maximale du matelas conseillé est 260mm.**
6. **AVERTISSEMENT:** Il convient de ne pas utiliser le lit surélevé lorsqu'une partie de la structure manque ou est cassée
7. **AVERTISSEMENT :** Les lits surélevés et le lit supérieur des lits superposés ne conviennent pas aux enfants de moins de 6 ans, en raison des risques de blessures dues aux chutes
8. **AVERTISSEMENT :** Attention aux articles tels que des cordes, des ficelles, des cordons, des harnais et des ceintures attachés ou accrochés sur un lit superposé ou surélevé afin d'éviter aux enfants de s'étrangler.
9. **AVERTISSEMENT :** «Les enfant peuvent se retrouver piégés entre le lit et le mur. Pour éviter le risque de blessure grave la distance entre la barrière de sécurité supérieure et le mur ne doit pas excéder 75 mm ou doit être d'au moins 230 mm»
10. Conforme à la norme européenne EN747.2012+A1.2015.
11. Ne jamais laisser des enfants sans un minimum de surveillance
12. Aucun jeu brutal ne doit être permis dans et sous le lit haut.
13. Il est interdit d'avoir plus d'une personne dans le lit haut.
14. Ne pas permettre aux enfants de se basculer ou de sauter sur ou sous le lit.
15. Utiliser toujours l'échelle pour monter ou descendre du lit haut.
16. Ne pas remplacer les pièces originales par des substitutions. Obtenir les pièces de rechange du magasin ou du fabricant.
17. L'utilisation d'une veilleuse de nuit peut procurer plus de sécurité à l'enfant couchant dans le lit haut.
18. Assurer une ventilation suffisante dans la chambre pour garder l'humidité relative faible donc ce moule dans et autour du lit peut être évité

GB Instructions for use

IMPORTANT - PLEASE READ CAREFULLY - KEEP FOR FUTURE REFERENCE

1. Use the tools indicated on the assembly leaflet and follow the instructions. Always follow the manufacturer's instructions.
2. All assembly components must always be tightened properly. Check regularly and retighten if necessary.
3. The positioning and means of access to the bed are indicated on the assembly leaflet.
4. **Do not exceed the maximum mattress thickness as the dotted line sticker indicated on bunk bed.**
5. Maximum recommended mattress size: 2000 x 900. The maximum mattress height is 260mm.
6. **WARNING :** The high sleeper must not be used if a part of the structure is missing or broken.
7. **WARNING :** High beds and the upper bed of bunk beds are not suited to children below the age of 6 years due to the risk of injury in the event of a fall.
8. **WARNING :** Do not attach or suspend items such as ropes, strings, cords, harnesses and belts on a bunk bed or high sleeper to avoid the possibility of strangulation.
9. **WARNING:** Children may become trapped between the bed and the wall. To avoid the risk of serious injury, the distance between the top safety barrier and the wall must not exceed 75 mm or must be at least 230 mm.
10. Compliant with European Standard EN 747.2012+A1.2015.
11. Never leave children without a minimum of supervision.
12. Children must not be allowed to play roughly on or under the top bunk.
13. It is forbidden to have more than one person in the top bunk.
14. Do not allow children to swing or jump on or under the bed.
15. Always use the ladder to climb up to and down from the top bunk.
16. Do not replace original parts with substitutes. Spare parts must be obtained from the store or manufacturer.
17. Use of a night-light will improve safety for a child sleeping in the top bunk.
18. Provide a good ventilation in the room to keep the humidity low and to prevent mould in and around the bed.

D BENUTZUNGSHINWEISE

WICHTIG - AUFMERKSAM LESEN - FÜR EINE SPÄTERE EINSICHT AUFBEWAHREN

1. Die in der Montage Anleitung angeführten Werkzeuge benutzen, die Montagehinweise beachten. Verwenden Sie immer die Betriebsanleitung des Herstellers.
2. Alle Elemente müssen korrekt verbunden und angezogen (notfalls nachziehen) sein und regelmäßig überprüft werden.
3. Die Position und der Zugang zum Bett sind in der Montageanleitung aufgeführt.
4. **Die maximale Stärke der Matratze einhalten, siehe Angaben auf das Etikett die auf das Bett geklebt ist.**
5. Empfohlene Abmessungen der zu Matratze 2000 x 900 maximal. Die max. Matratzenhöhe ist 260mm.
6. **WARNUNG** : Das Etagenbett darf nicht benutzt werden wenn die Struktur oder ein Teil der Struktur fehlt oder beschädigt ist.
7. **WARNUNG** : Hohe Betten und das obere bed von Etagenbetten sind nicht für Kinder unter 6 Jahren geeignet (Verletzungs- und Unfallgefahr)
8. **WARNUNG** : Vorsicht ist weiterhin geboten mit am Etagenbett befestigten Seilen, Kordeln, Bändern, oder Sicherheitsgeschirr, hier besteht Strangulierungsgefahr für Kinder.
9. **WARNUNG** : «Kinder können sich zwischen dem Bett und der Wand eingeklemmt finden. Um Unfälle zu vermeiden, darf der Abstand zwischen der oberen Sicherheitsleiste und der Wand nicht mehr als 75 mm betragen oder muß wenigstens 230 mm betragen .
10. Entsprechend der europäischen Norm EN747.2012+A1.2015
11. Kinder niemals ohne ein Minimum von Aufsicht lassen.
12. Brutale Spiele dürfen in oder auf dem oberen Bett nicht zugelassen werden.
13. Im oberen Bett darf nur eine Person schlafen.
14. Die Kinder dürfen nicht auf das Bett springen oder schaukeln.
15. Nur die Leiter zum Hinaufsteigen und Herabsteigen des oberen Bettes benutzen.
16. Nur Originalteile bei Reparaturen verwenden. Die Austauschteile nur im Fachhandel oder beim Hersteller einkaufen.
17. Die Benutzung einer kleinen Lampe kann dem Kind im oberen Bett ein Sicherheitsgefühl verleihen.
18. Eine gute Belüftung und Feuchtigkeitsaustausch bei der Liegefläche ist gewährleistet, um Schimmelbildung zu vermeiden.

NL Gebruiksaanwijzing

BELANGRIJK - AANDACHTIG LEZEN - BEWAREN VOOR LATERE NASLAG

1. Gebruik het op de montagehandleiding aangegeven gereedschap, volg de assemblageinstructies en gebruik steeds de gebruiksinstructie van de fabrikant.
2. Alle bevestigingsmiddelen van de assemblage moeten behoorlijk zijn vastgedraaid, regelmatig worden gecontroleerd en zonodig opnieuw worden aangehaald.
3. De plaatsing en de wijze van toegang tot het bed zijn op de montagehandleiding aangegeven.
4. **Houd u aan de maximale matrasdikte, zie de markering op het etiket dat op het bed gekleefd is.**
5. Aanbevolen matrasafmeting : maximum 2000 x 900mm. De maximale matrashoogte bedraagt 260mm.
6. **WAARSCHUWING** : Het hoge bed mag niet gebruikt worden, wanneer een deel van de structuur ontbreekt of kapot is.
7. **WAARSCHUWING** : Hoogslapers en het bovenste bed van het stapelbed zijn niet geschikt voor kinderen onder de 6 jaar, vanwege het gevaar van verwondingen door vallen.
8. **WAARSCHUWING** : Wees voorzichtig met dingen als koorden, touwtjes, snoeren, tuigjes en gordels die vastgemaakt zijn aan een hoog bed, om te voorkomen dat kinderen gekeeld worden en stikken.
9. **WAARSCHUWING** «Kinderen kunnen klem raken tussen het bed en de muur. Om ernstige verwondingen te voorkomen, moet de afstand tussen de bovenste veiligheidsstang en de muur niet meer zijn dan 75 mm of minstens 230 mm,»
10. Voldoet aan de Europese norm EN747.2012+A1.2015.
11. Laat kinderen nooit alleen zonder minimale bewaking
12. Verbied woeste spellen in en onder een verhoogd bed.
13. Er mag zich maar één persoon tegelijk in het hoge bed bevinden.
14. Laat kinderen niet wippen of springen in of onder het hoge bed.
15. Gebruik altijd de ladder om in en uit het hoge bed te klimmen.
16. Vervang de originele stukken niet door namaak. Betrek de vervangende onderdelen van uw leverancier of van de fabrikant.
17. Voorzie voldoende ventilatie in de kamer om de vochtigheid laag te houden zodat schimmel in en rond het bed kan vermeden worden.
18. Het gebruik van een nachtlampje kan kinderen in een verhoogd bed een veilig gevoel geven.

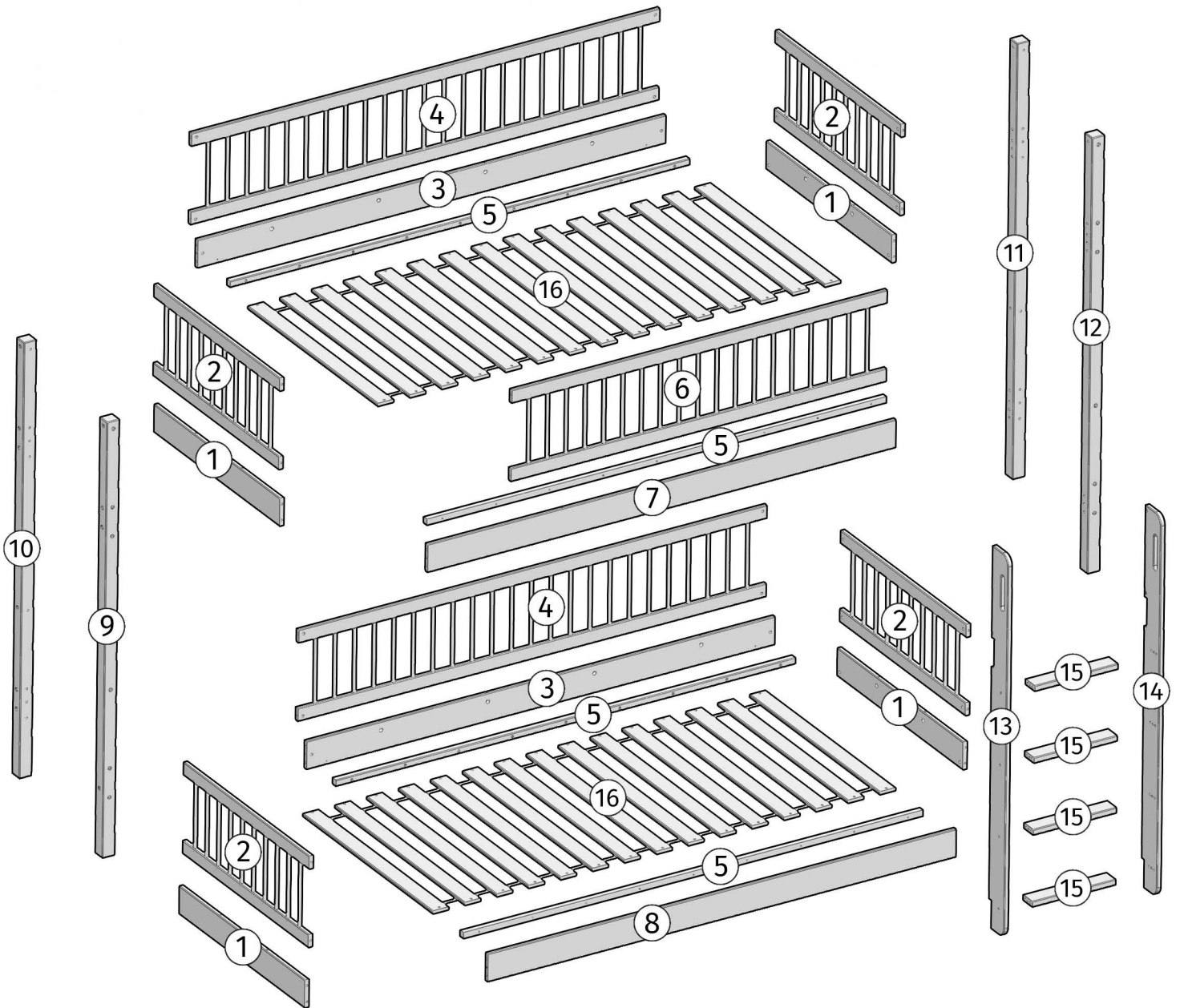
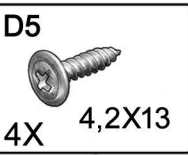
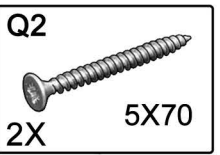
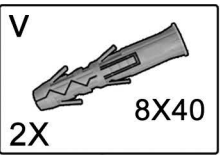
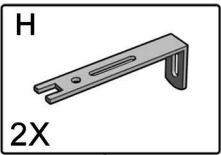
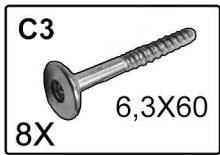
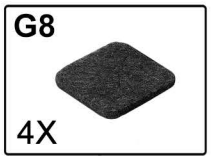
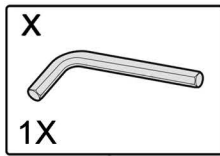
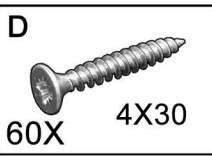
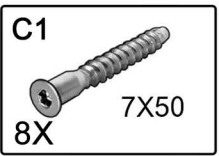
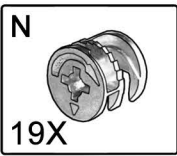
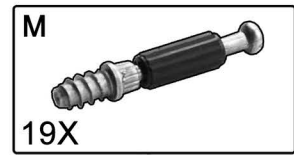
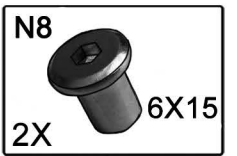
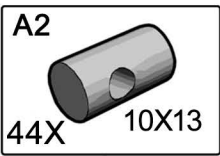
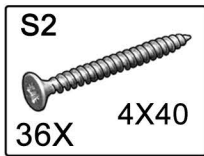
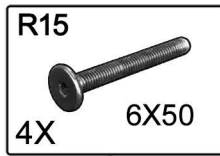
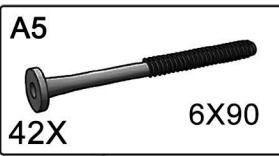
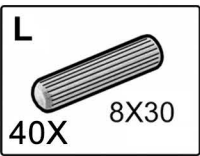

№	a*b*c	X	Paket N
1	866*115*20	4	2
2	866*320*20	4	1
3	1966*115*20	2	2
4	1966*370*20	2	1
5	1930*27*27	4	3
6	1576*370*20	1	1
7	1966*115*20	1	2
8	1966*115*20	1	2
9	1754*54*54	1	3
10	1754*54*54	1	3
11	1754*54*54	1	3
12	1754*54*54	1	3
13	1534*111*20	1	3
14	1534*111*20	1	3
15	350*68*25	4	2
16	1925*896*15	2	4

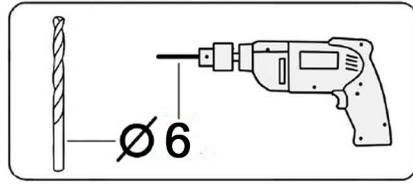

I

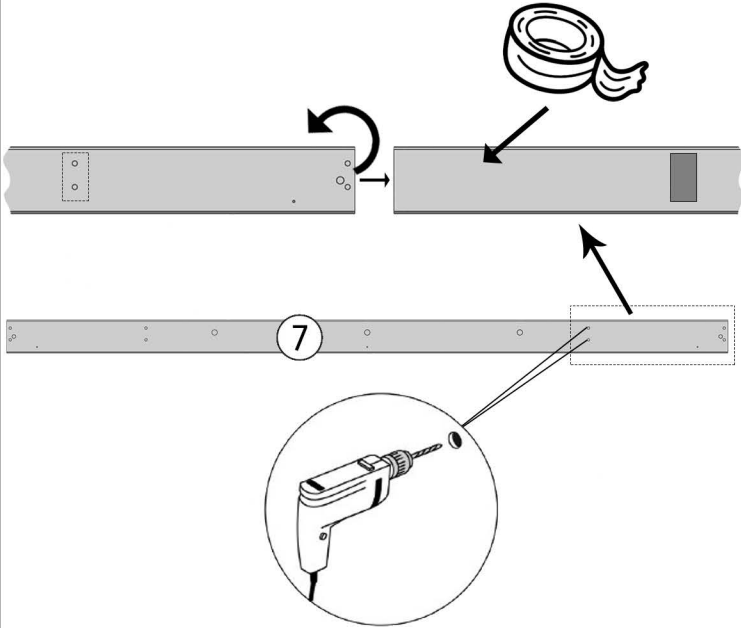

II

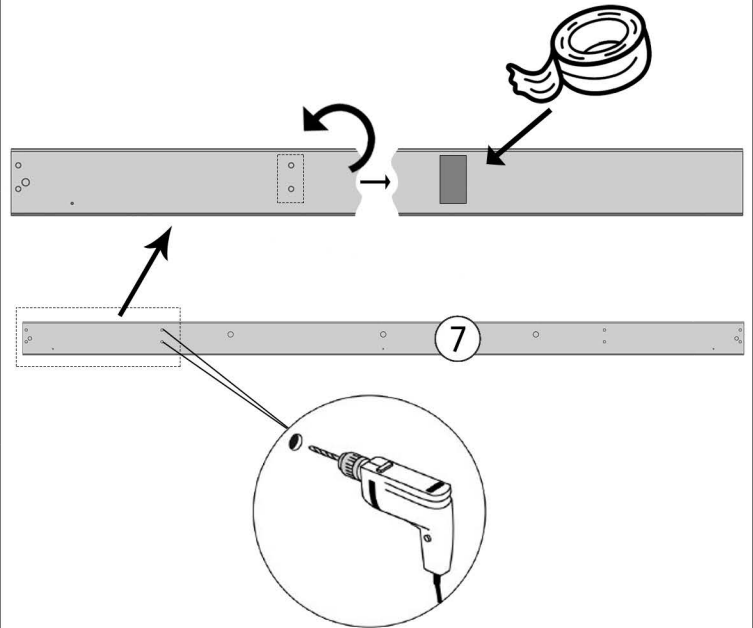

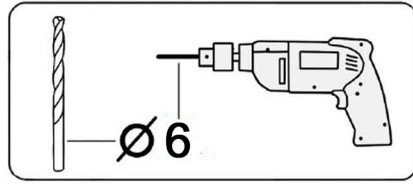

+



I

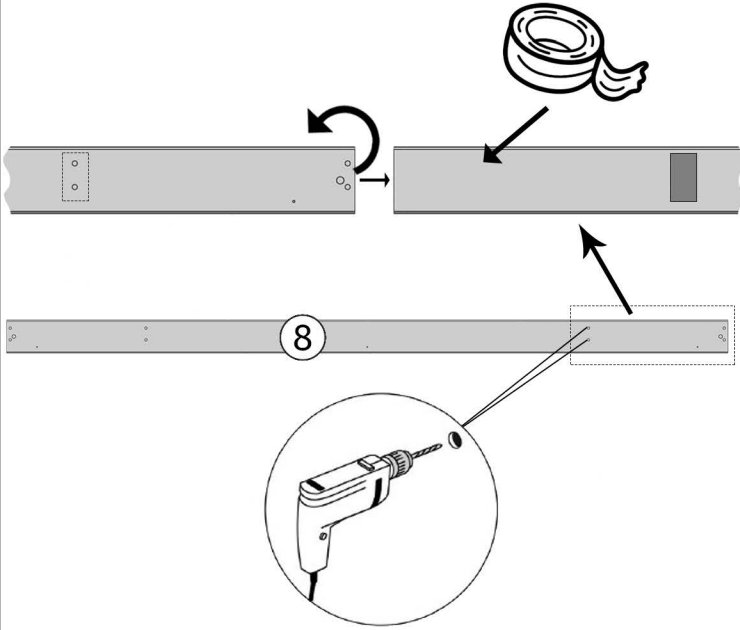

II

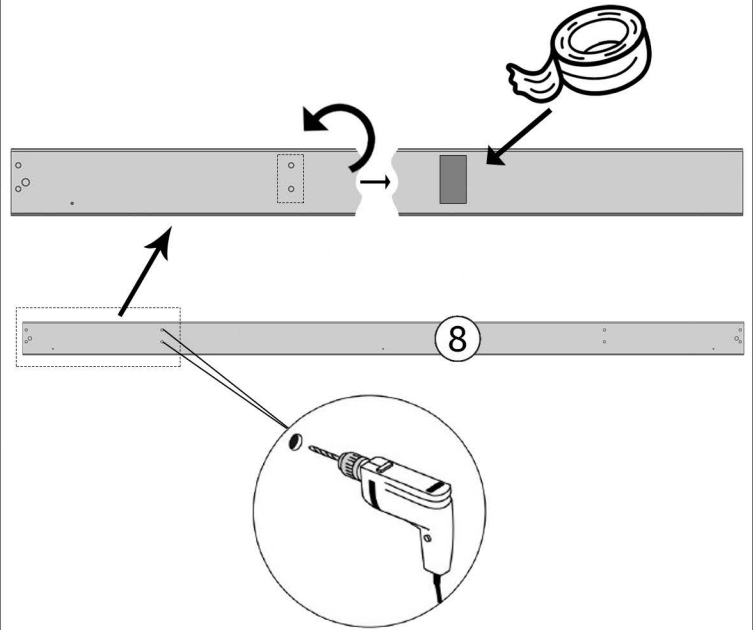

I

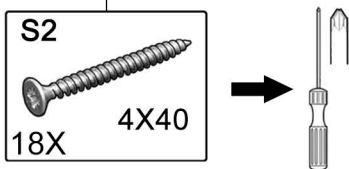
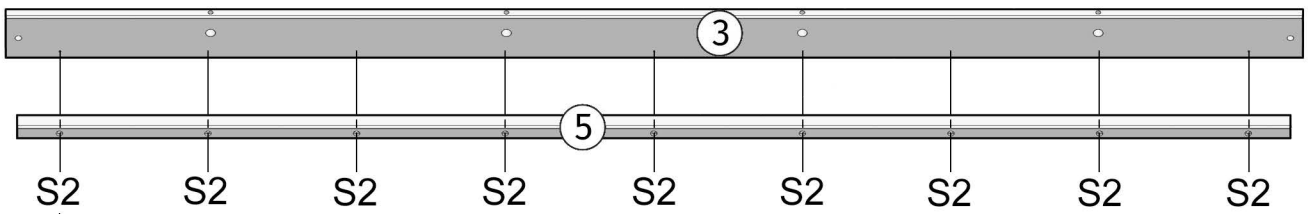
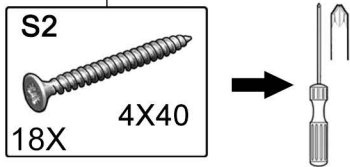
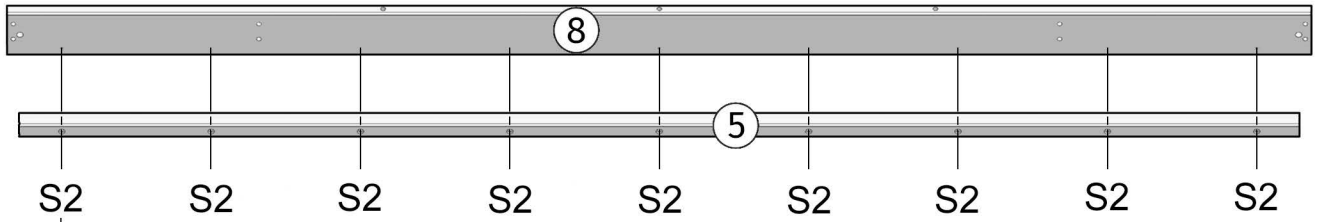
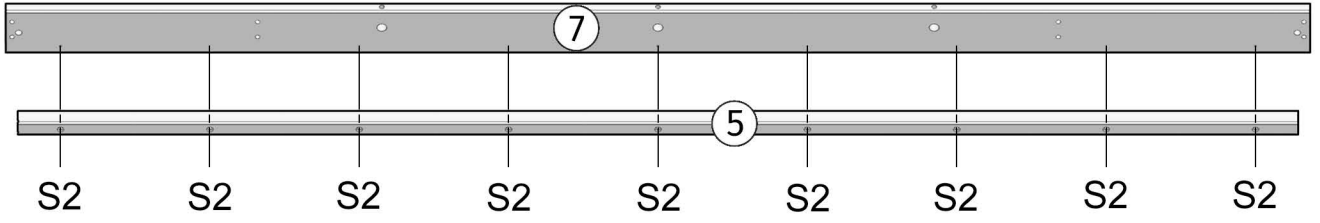

2X

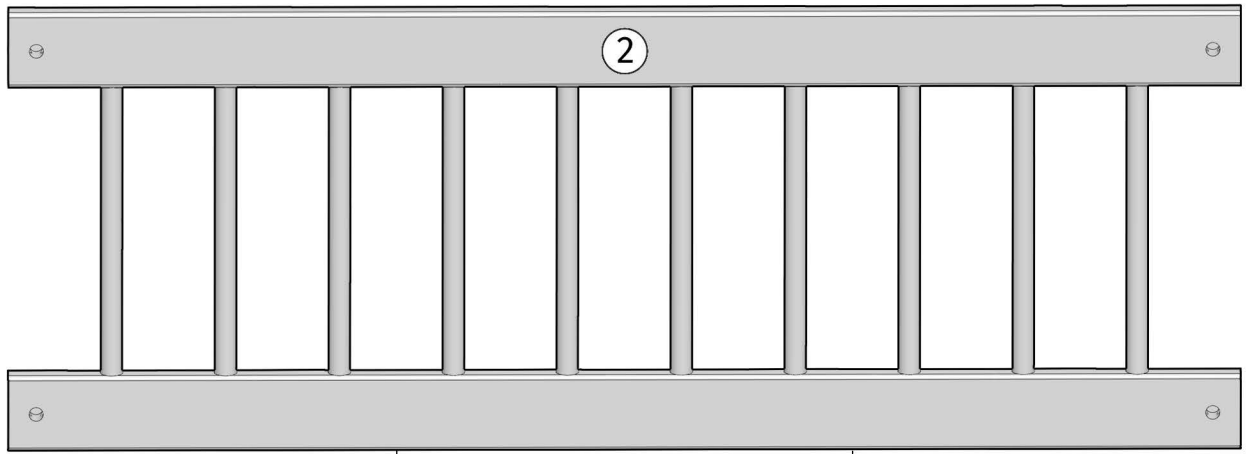

M ↓ ↓ M
N N

4X

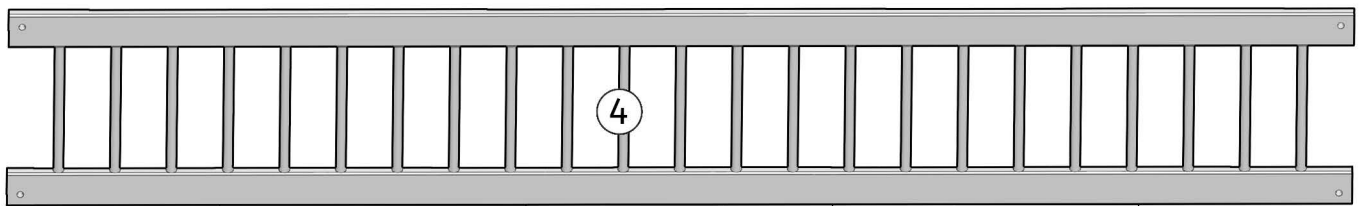
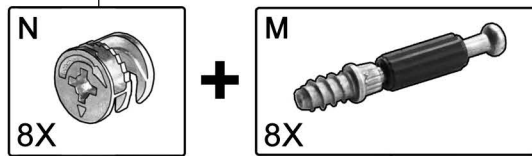

M M M M
↓ ↓
N N N N

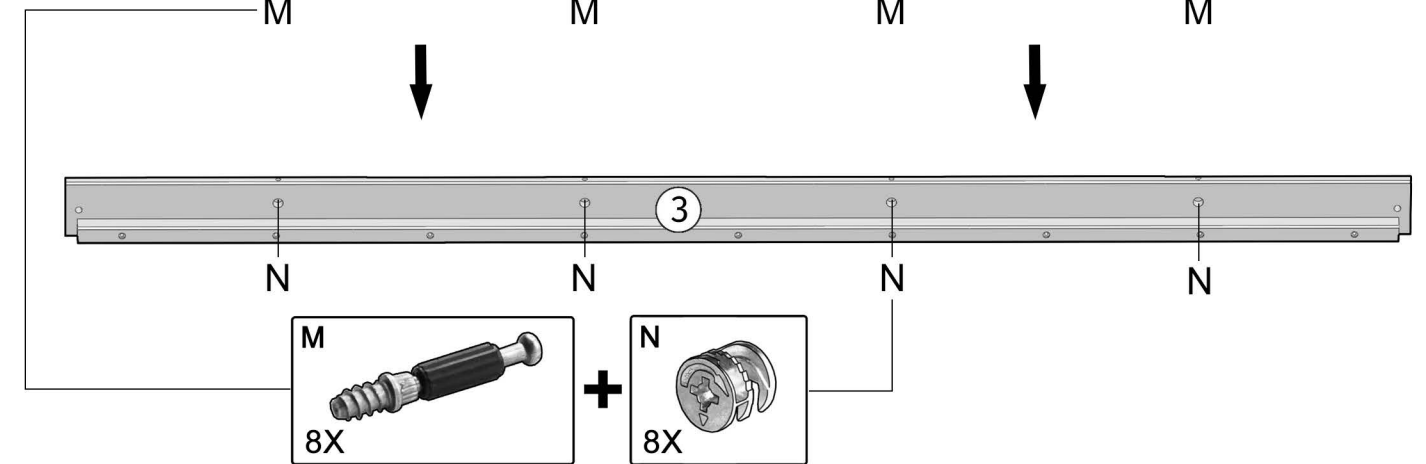

2X

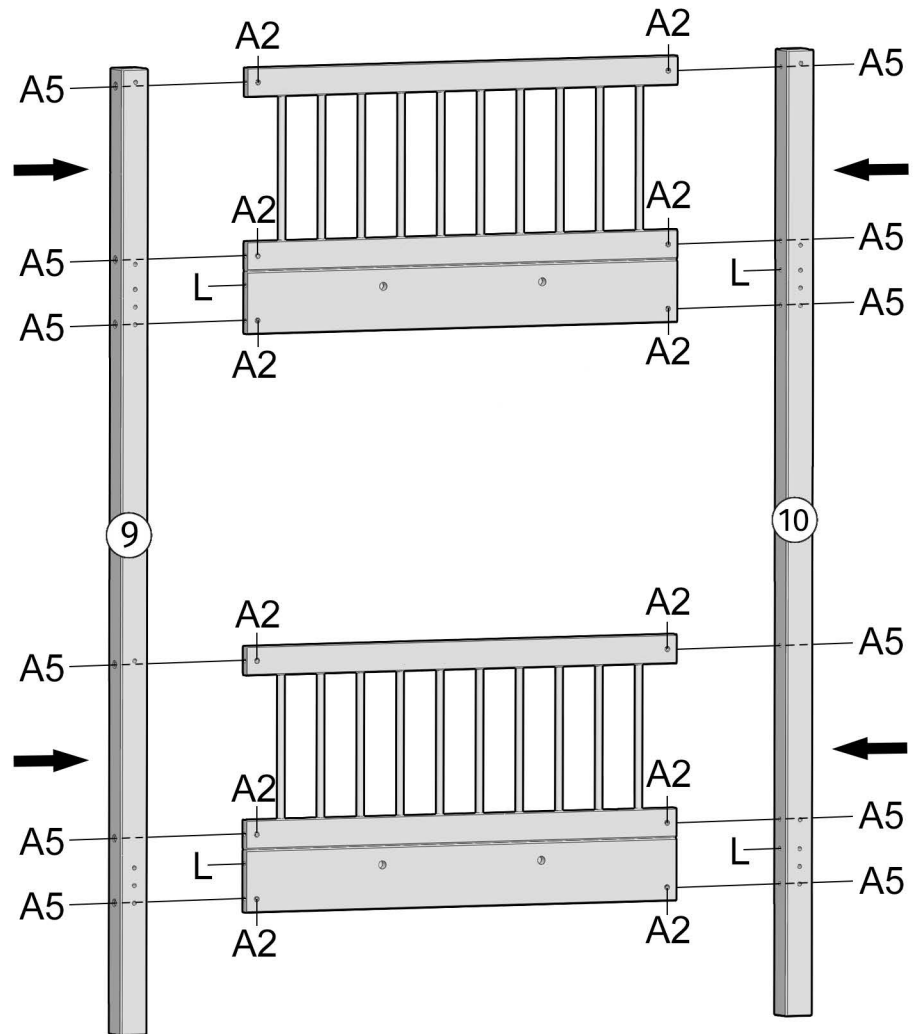
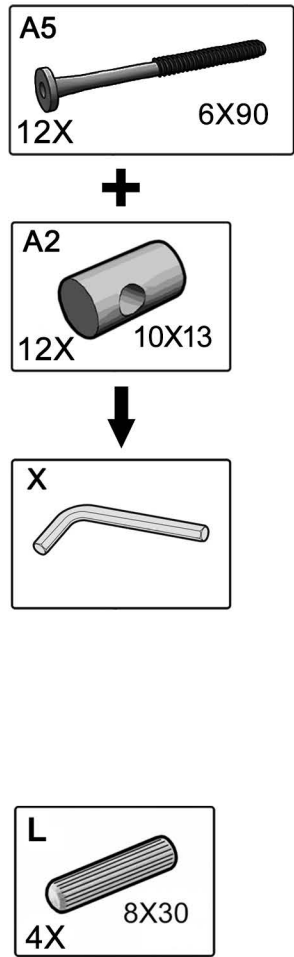
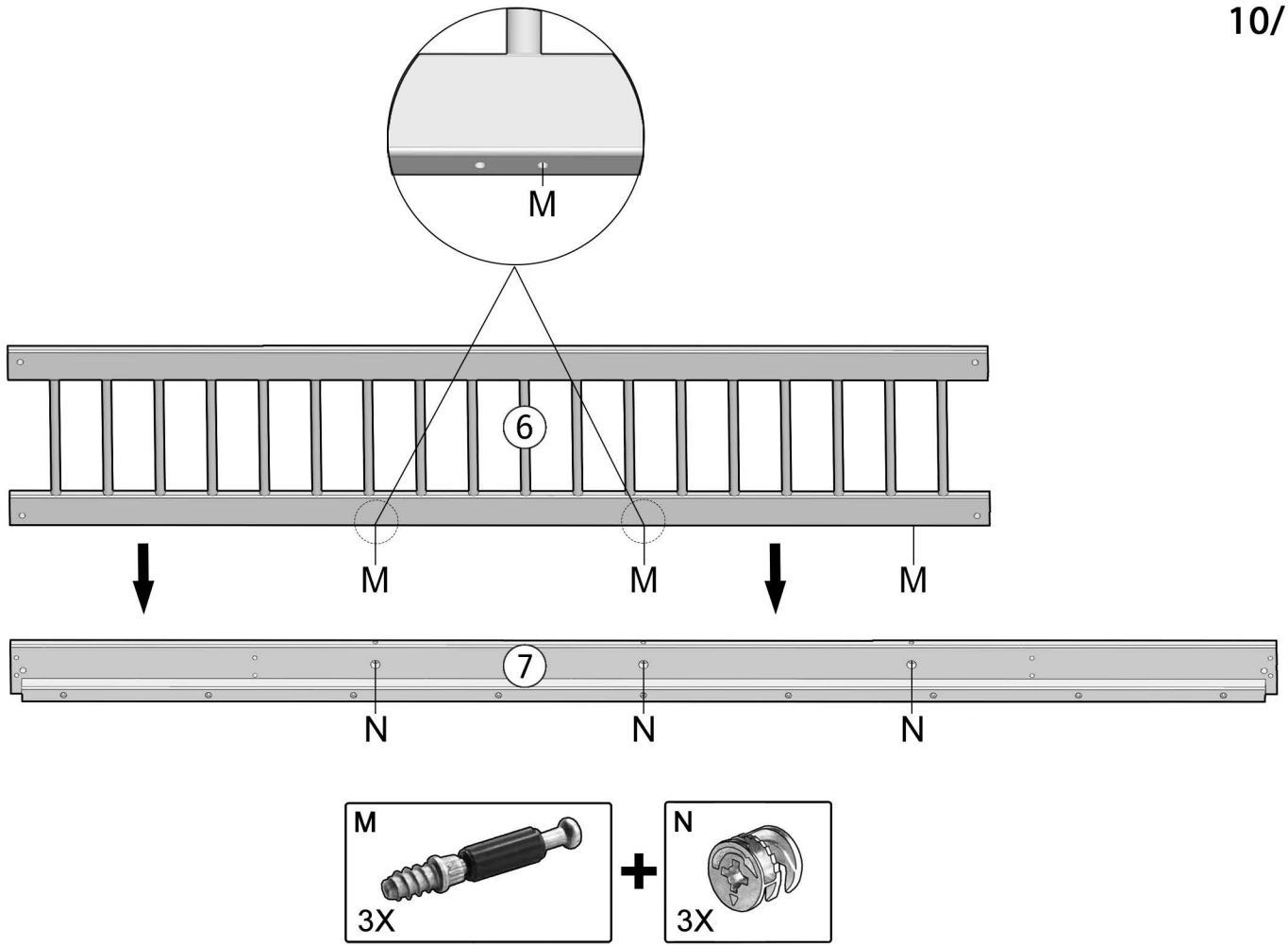

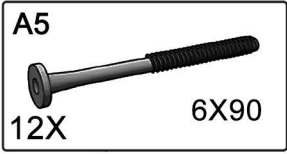

+

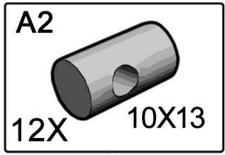

↓

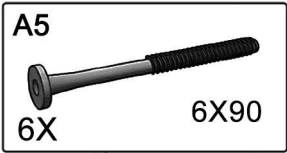
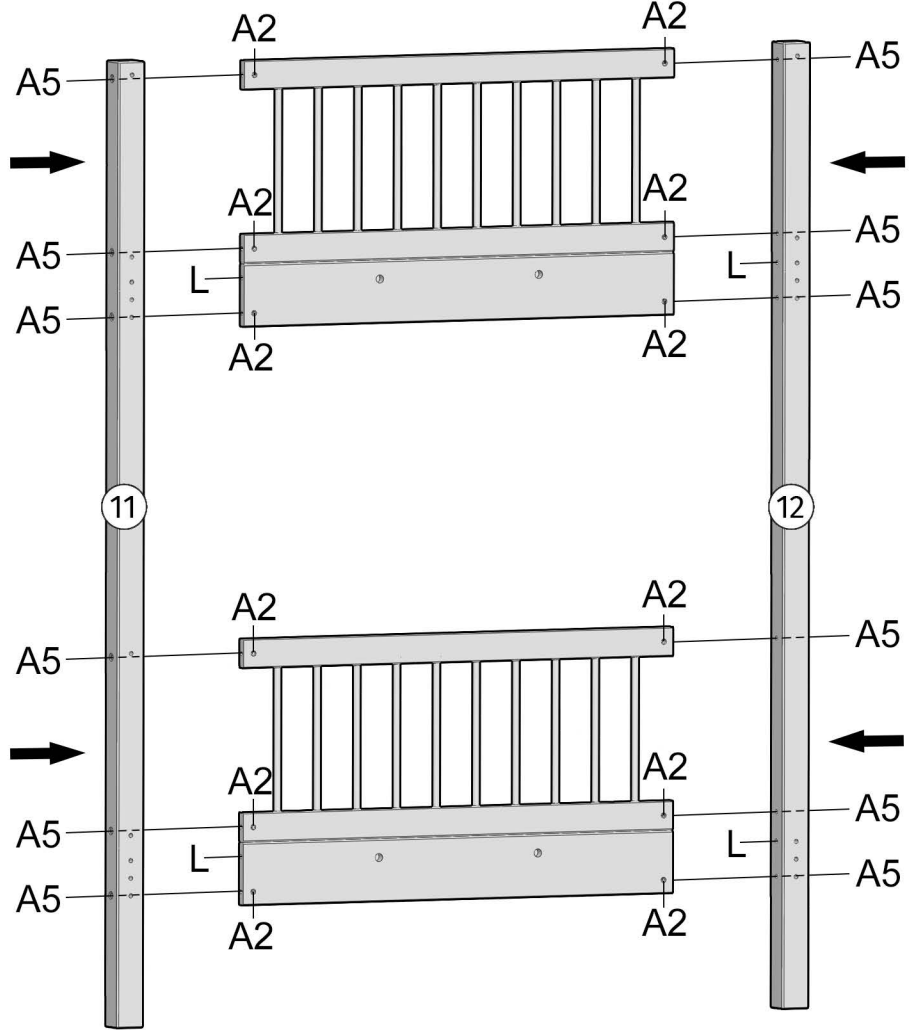
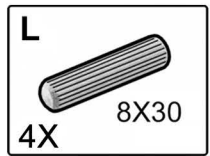
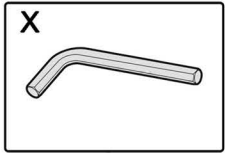

+

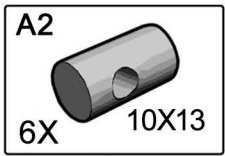

↓

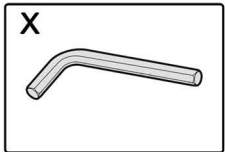

×
80%

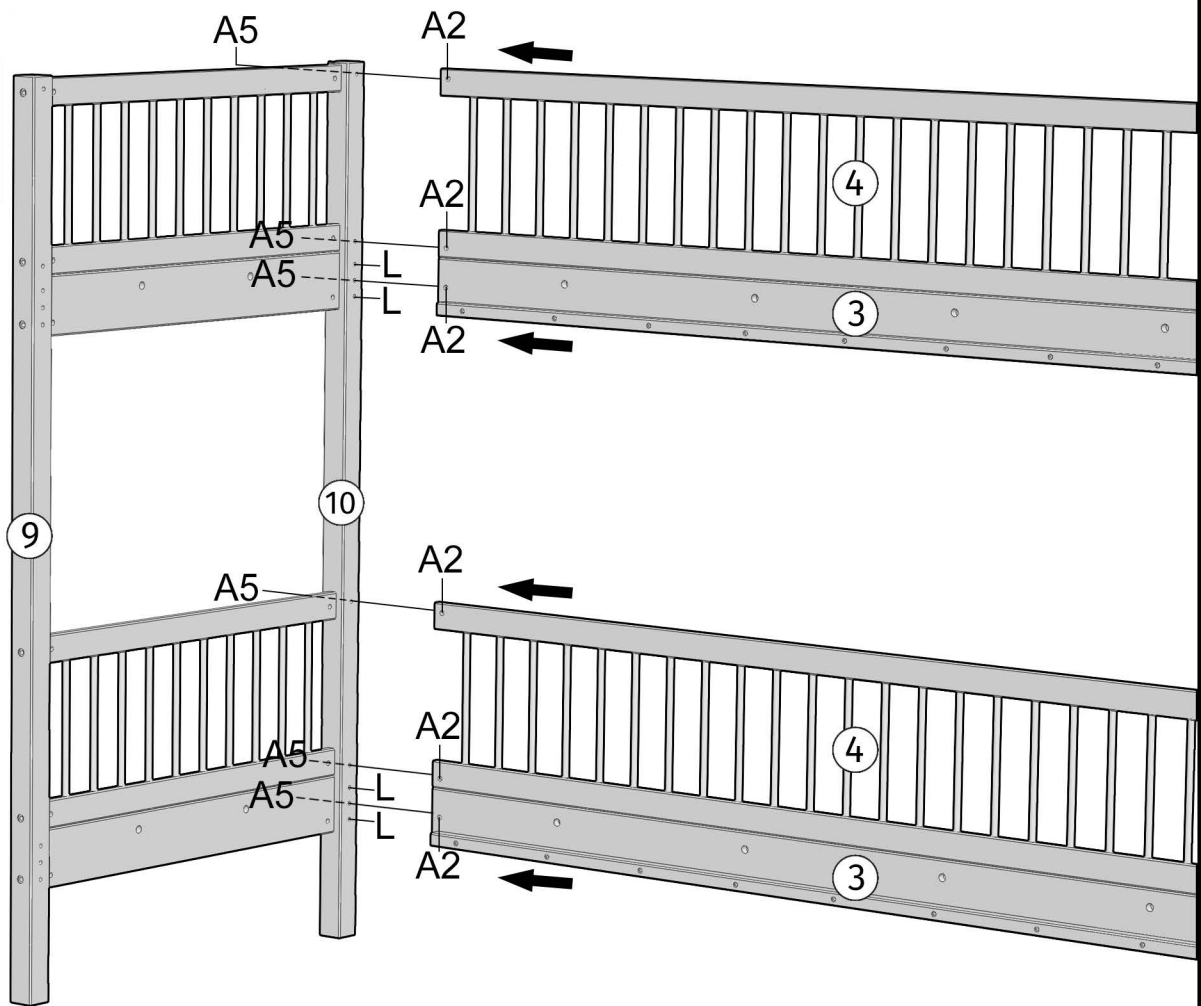
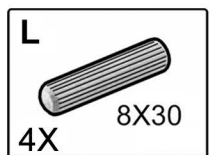

9

12/18

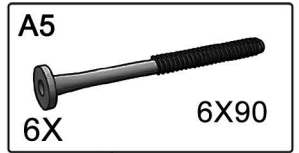
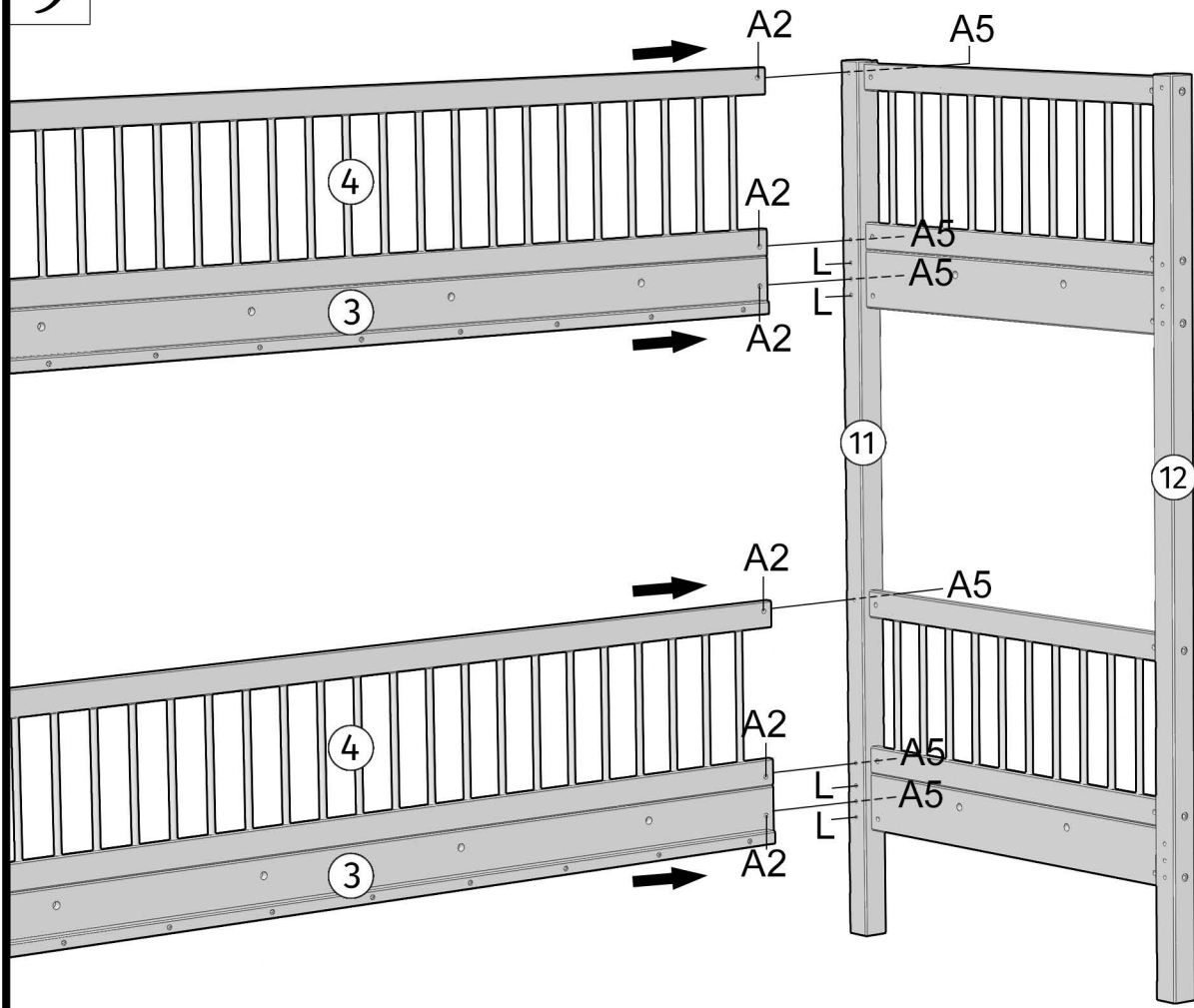

+

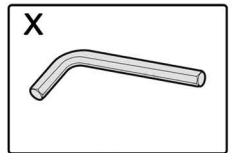
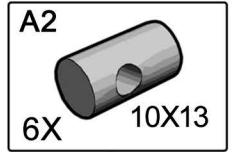

80%

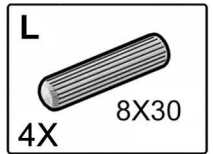

10

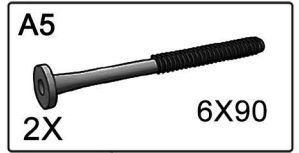
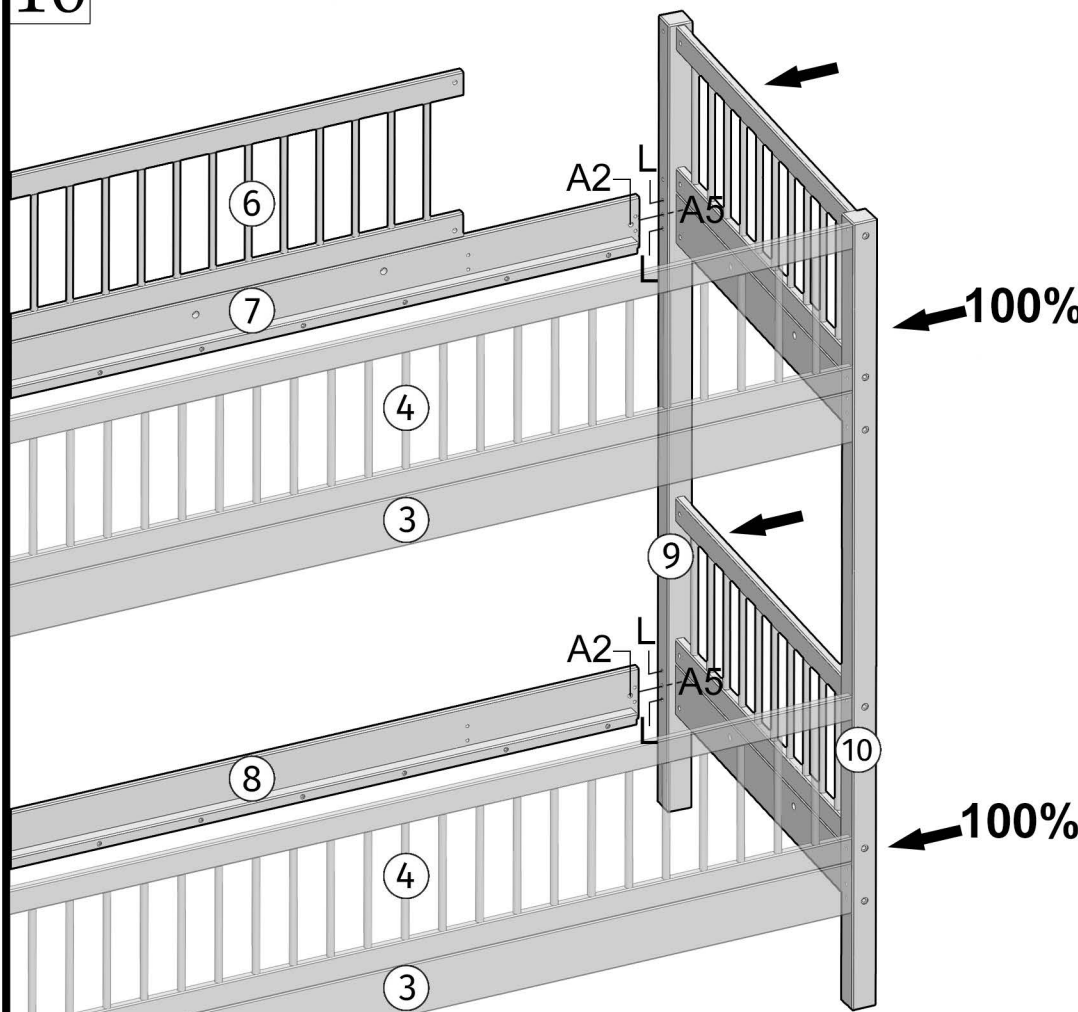

+

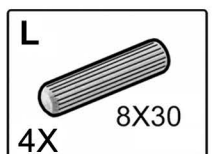
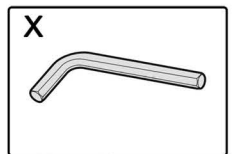
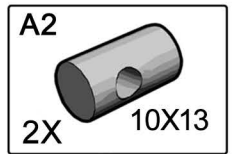

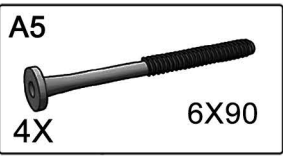

+

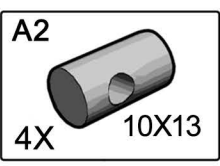

↓

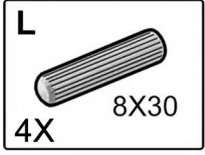
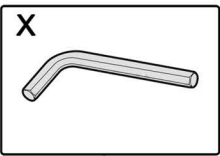

100%

100%

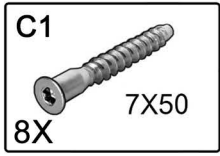
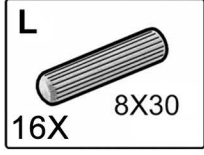
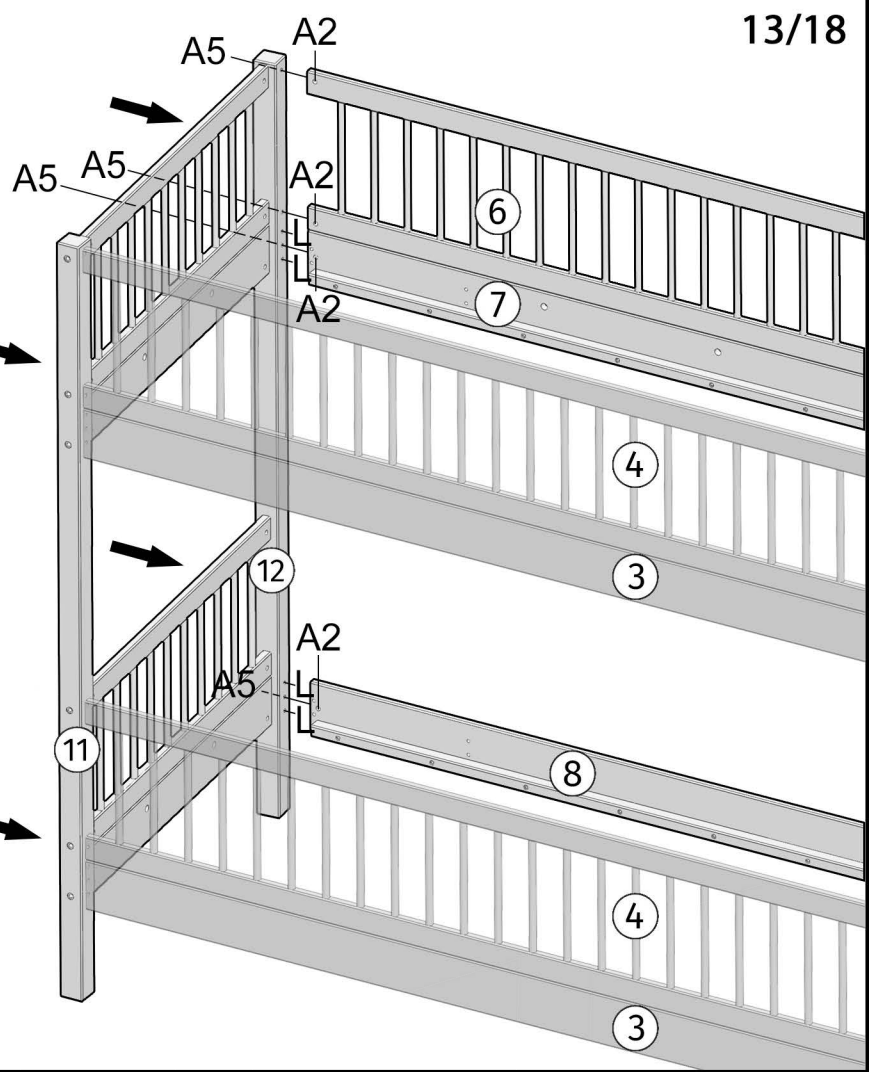

↓

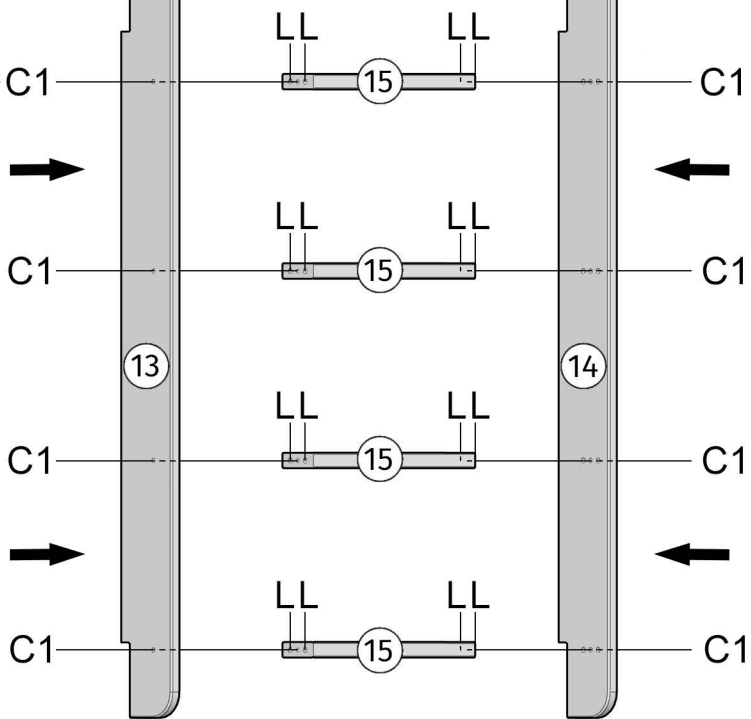
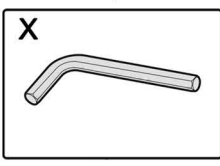

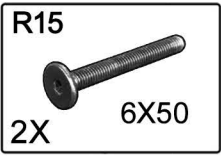
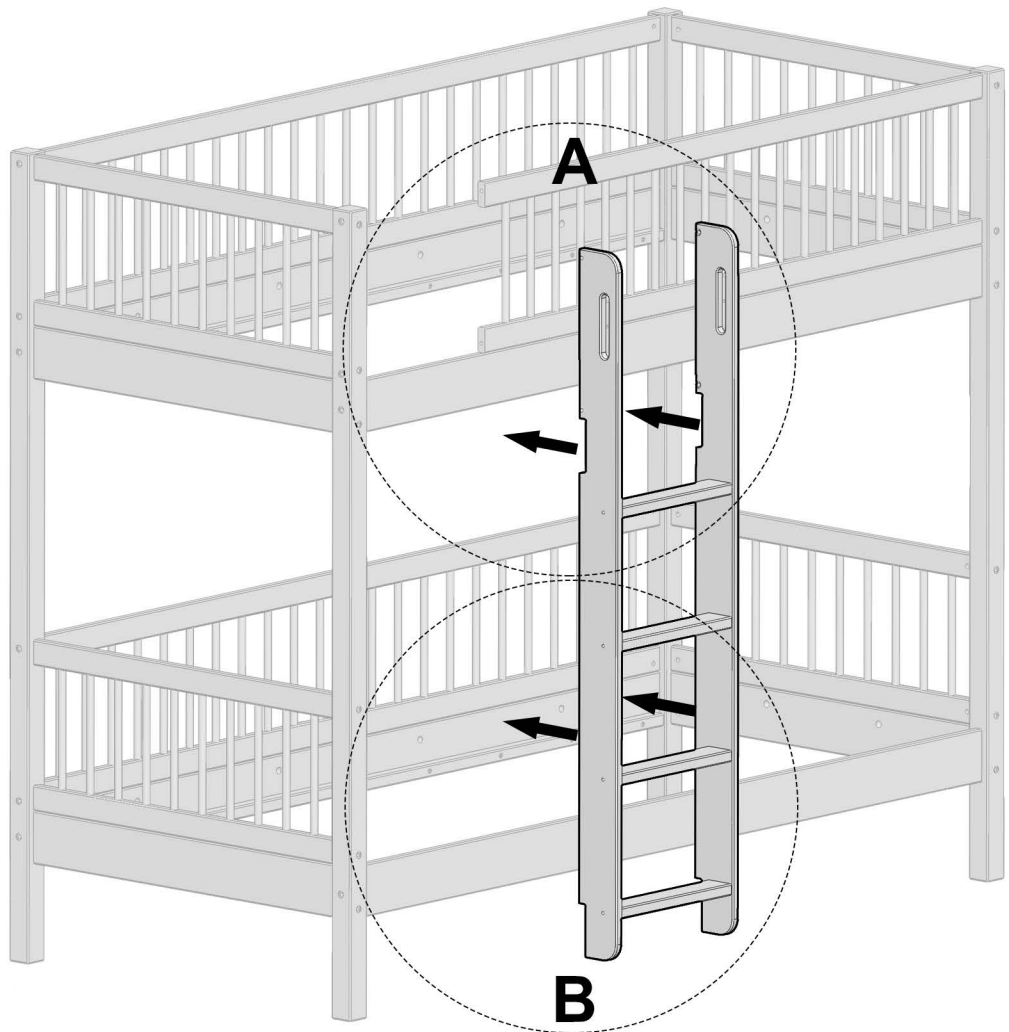

+

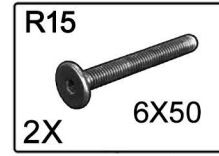
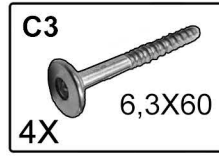
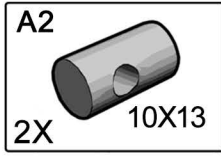

+

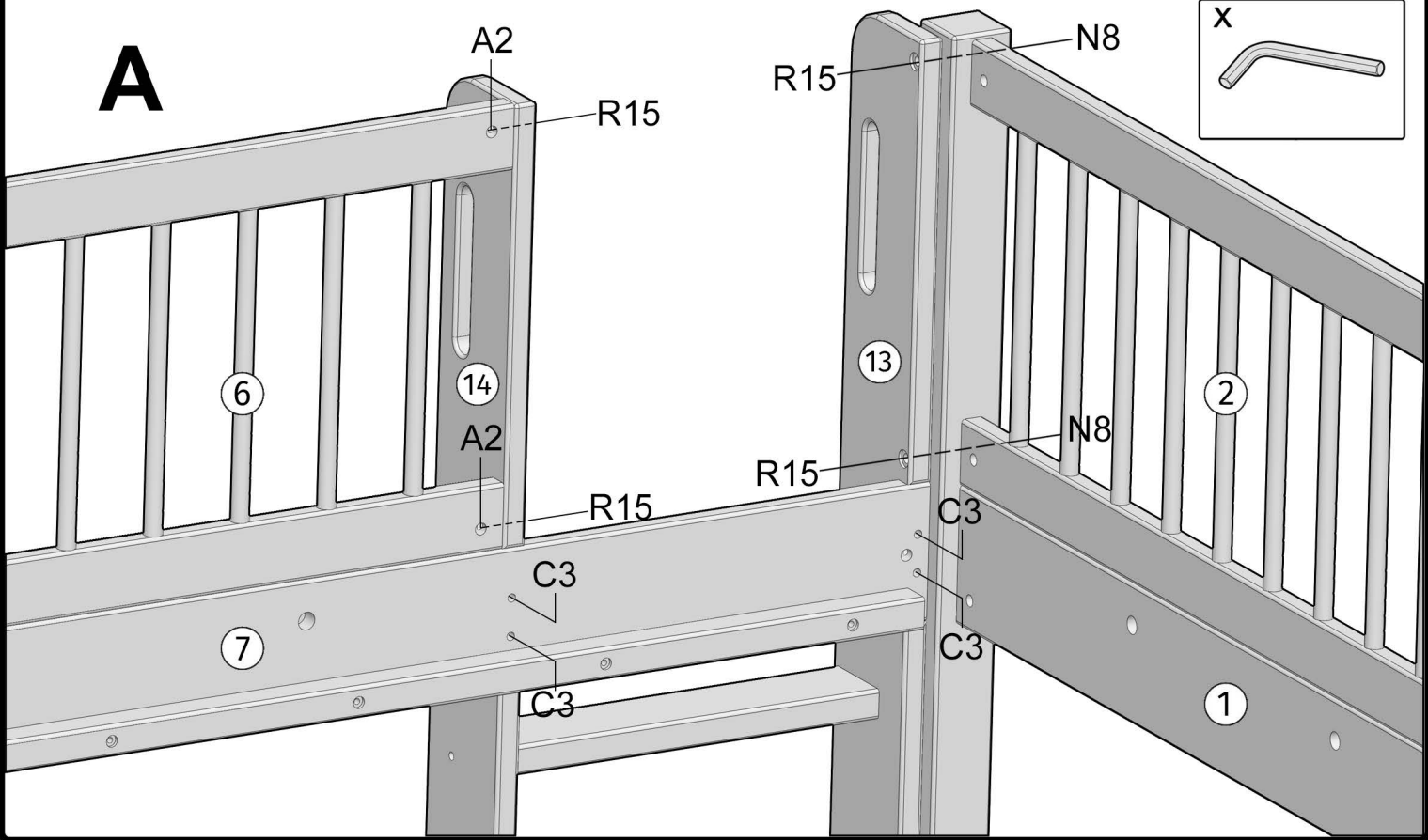
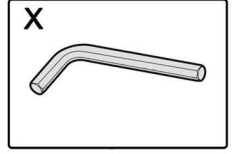
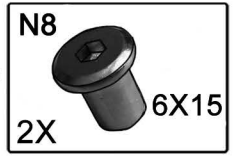

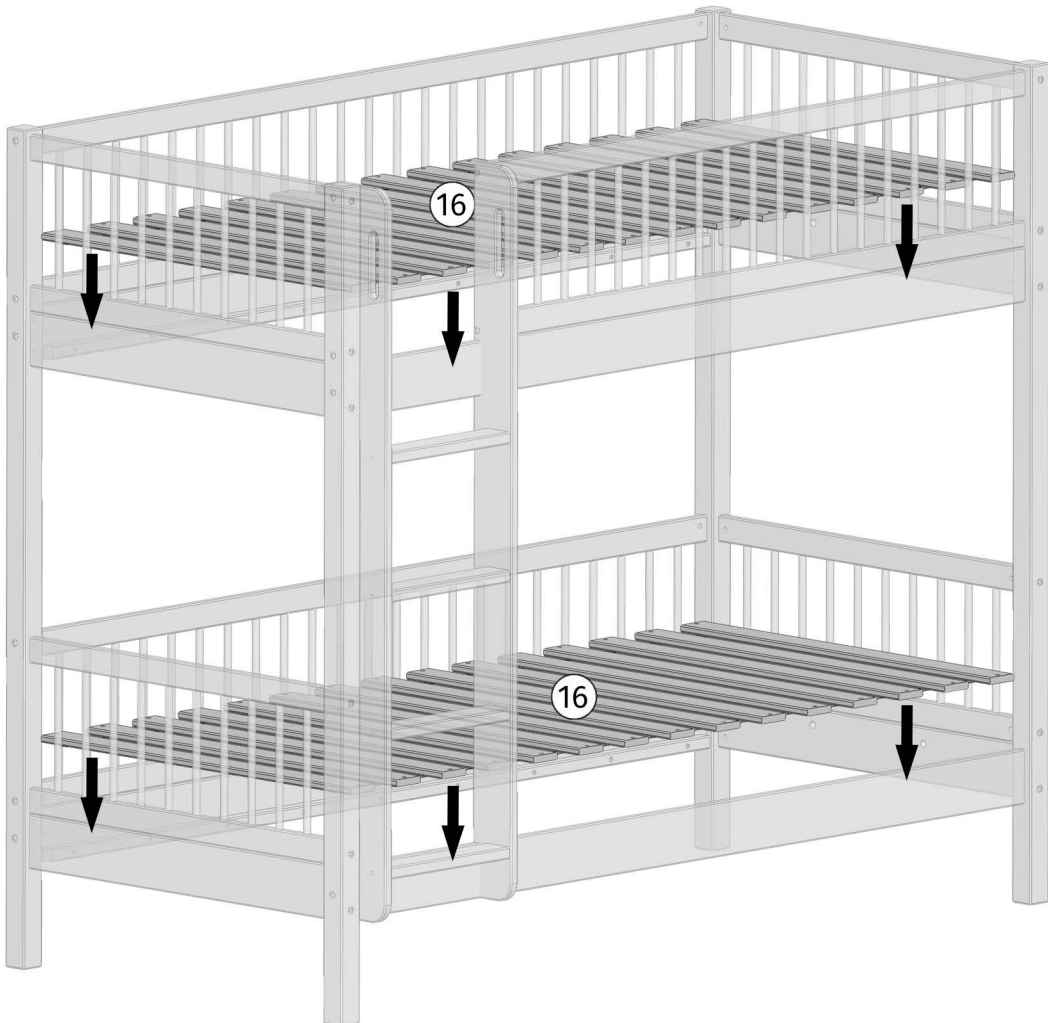
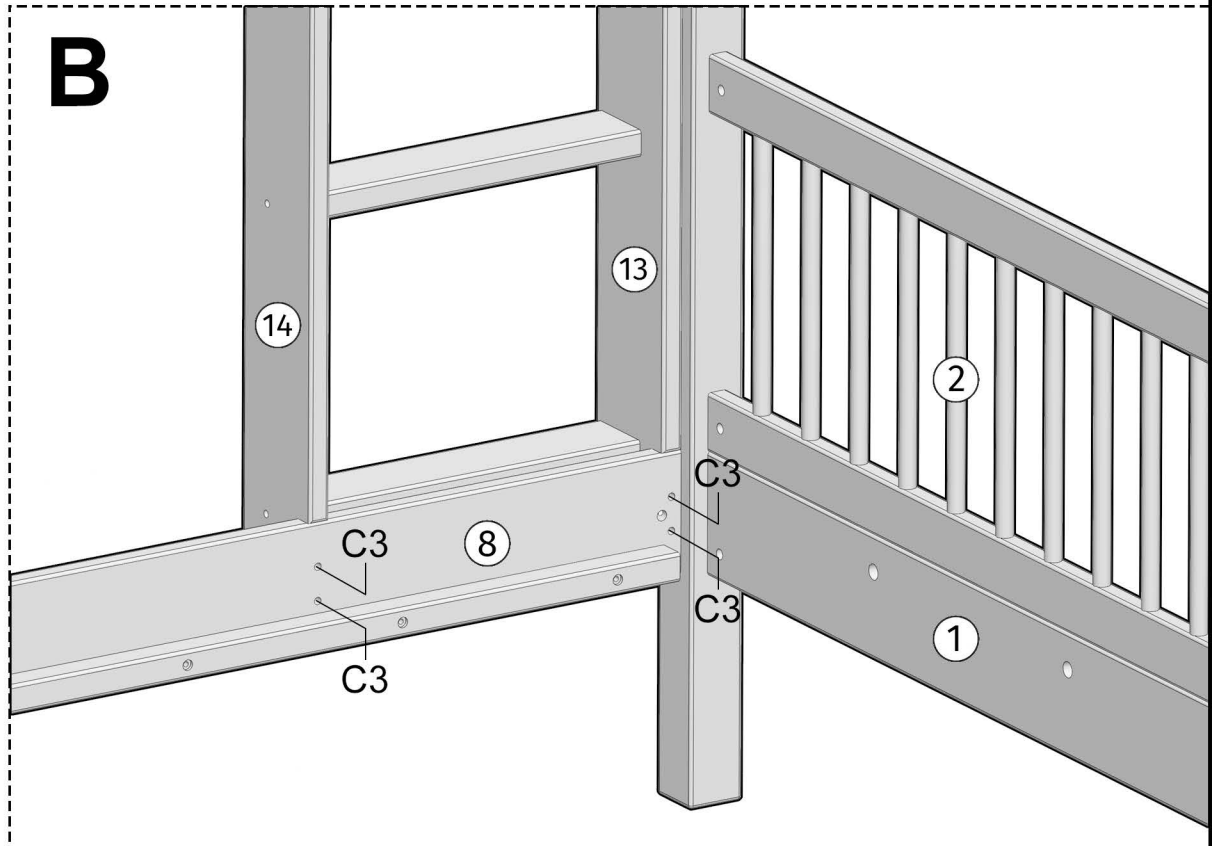
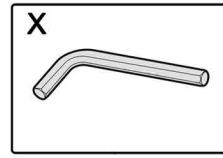
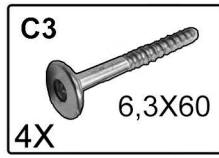

17

16/17

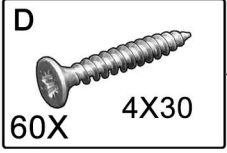

2X

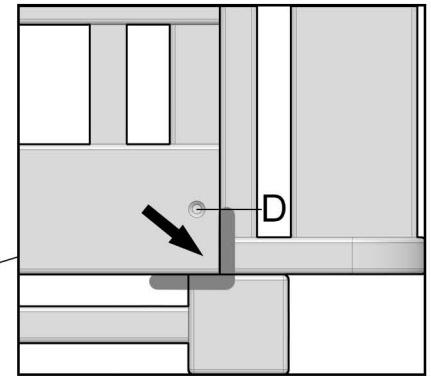
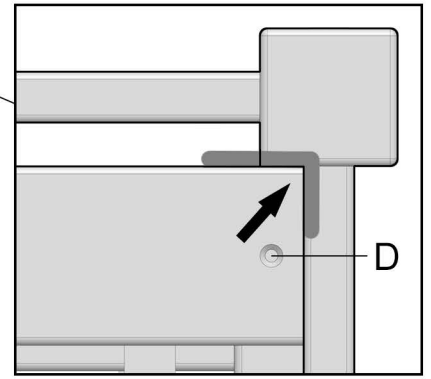
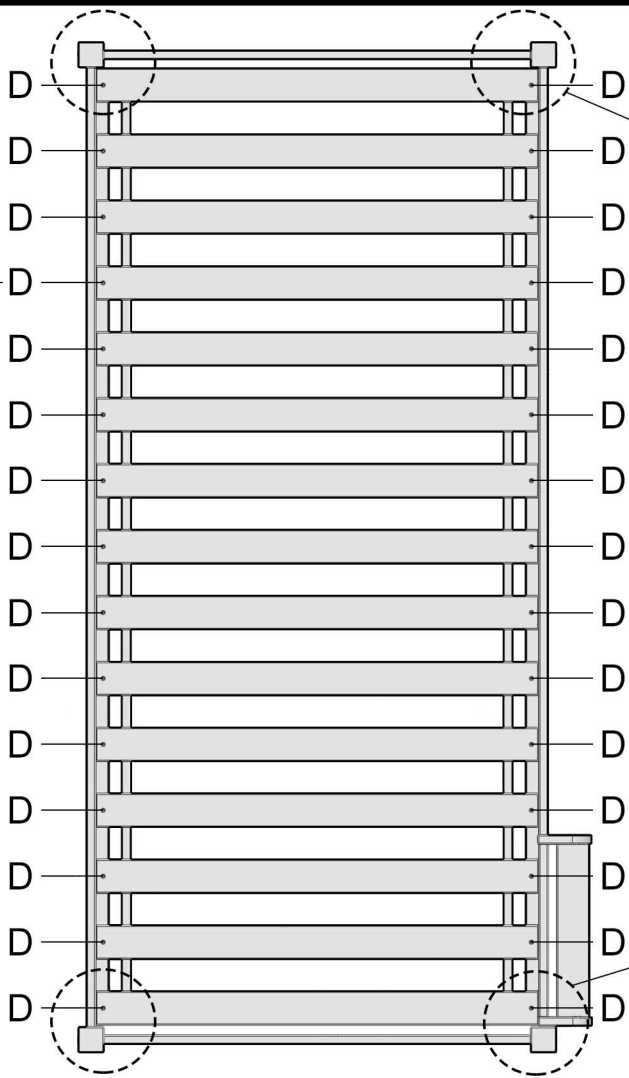

18

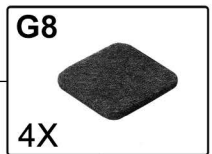
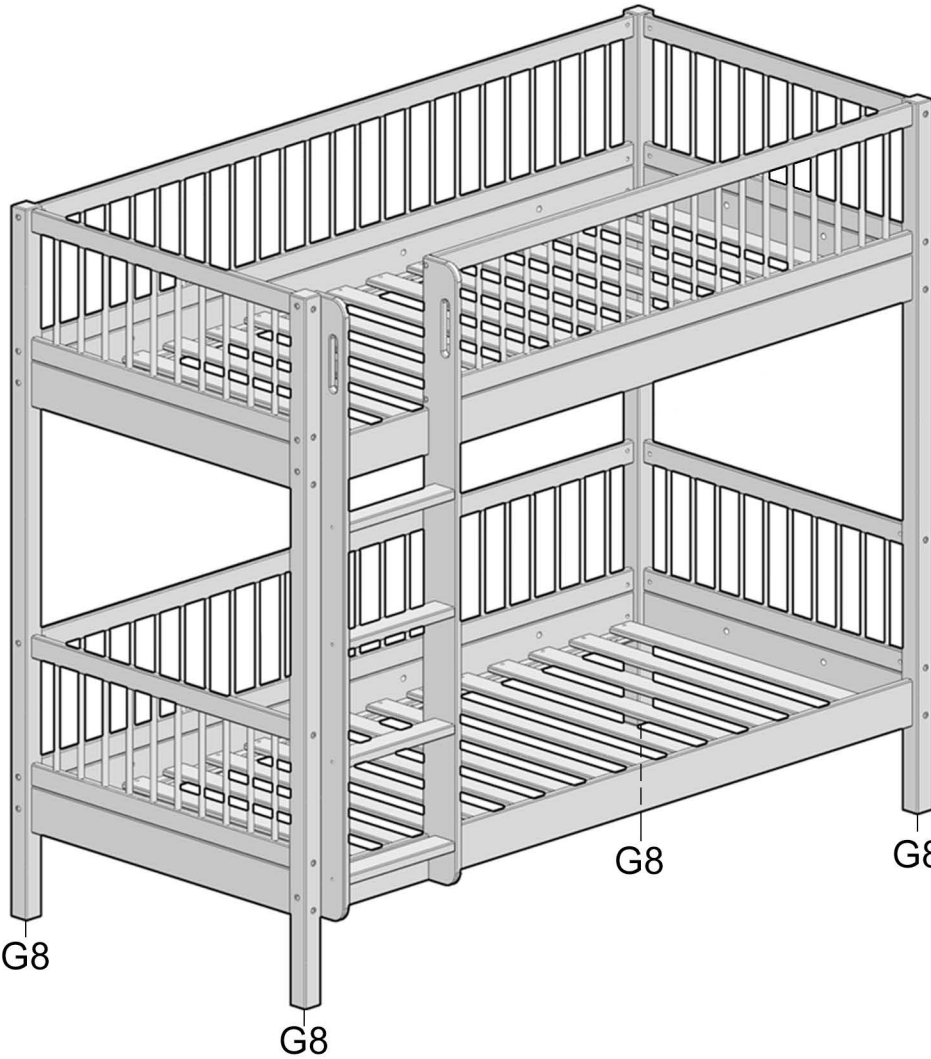

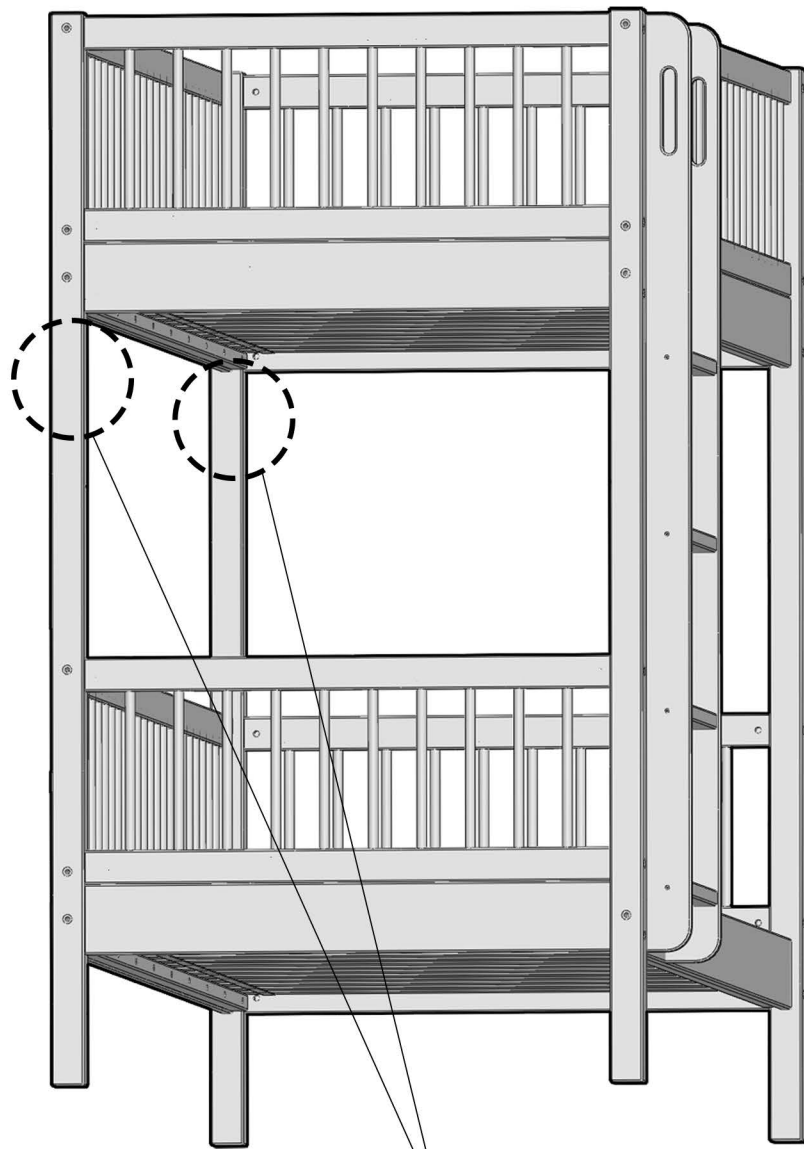
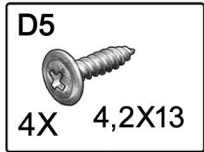
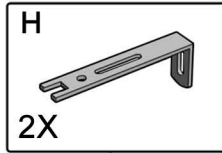

Important!

To secure the bed it is necessary to fix the bed to the wall by mounting the 2 brackets H as shown on the illustration.

Important!

Il est indispensable de fixer le lit mezzanine au mur avec les 2 équerres H

Utiliser des vis et des chevilles adaptés votre mur.

Wichtig!

Es ist notwendig das Bett an der Wand mit zu befestigen - siehe Zeichnung.

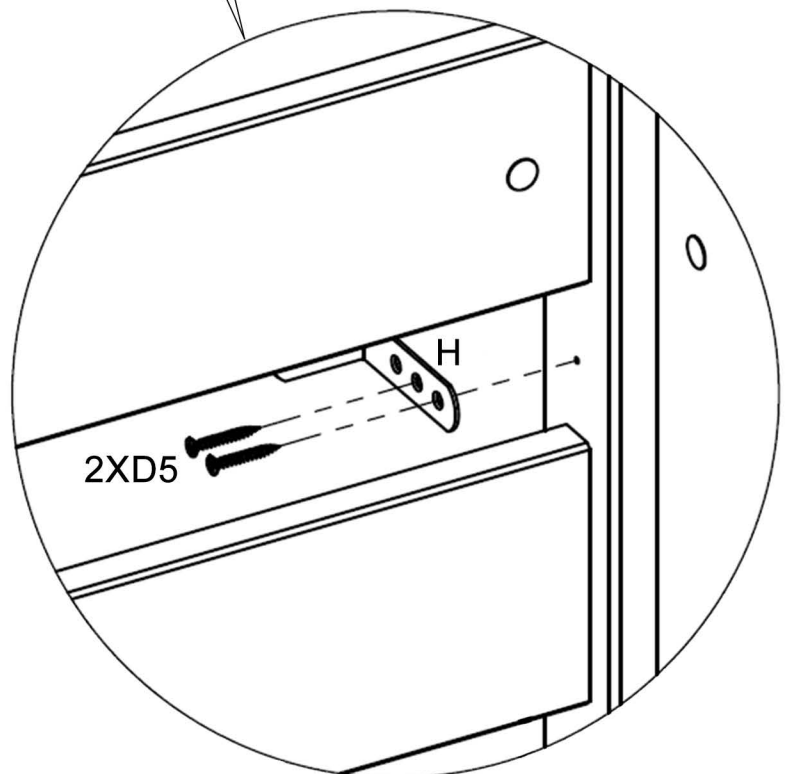

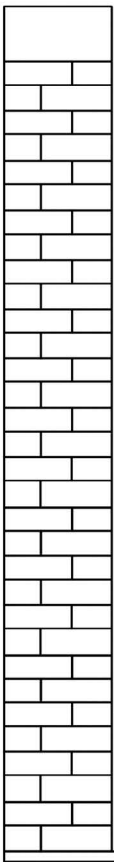

1

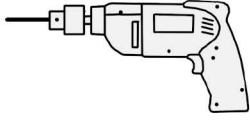

2

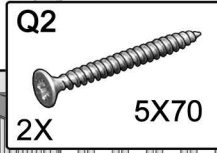
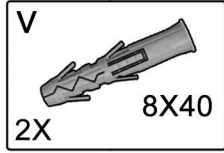
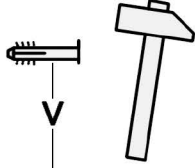

3

