

NOTICE DE MONTAGE

ASSEMBLING
INSTRUCTIONS
13.08.2021 rev 0

NIHAD POUF



x1



15 min



x2



PENSEZ AU TRI !
ENSEMBLE RÉDUISONS
L'IMPACT ENVIRONNEMENTAL
DES EMBALLAGES

ÉLÉMENT(S)
PLASTIQUE(S)



À JETER

ÉLÉMENT(S)
MÉTAL(S)
CARTON(S) PAPIER(S)



À RECYCLER

CONSIGNE POUVANT VARIER LOCALEMENT
> WWW.CONSIGNEDETRI.FR

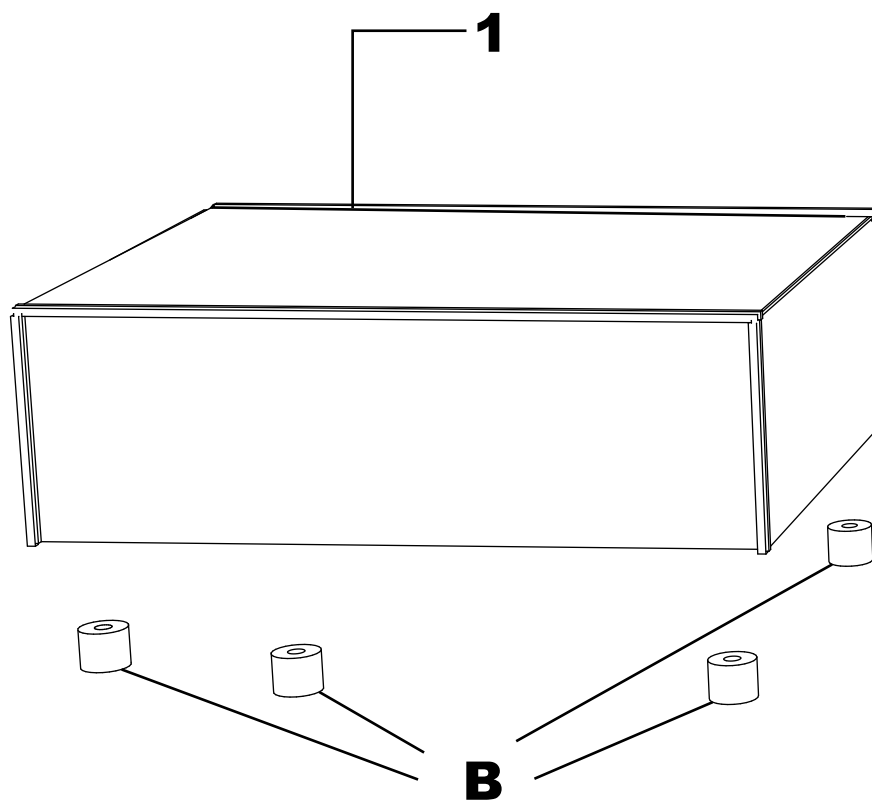
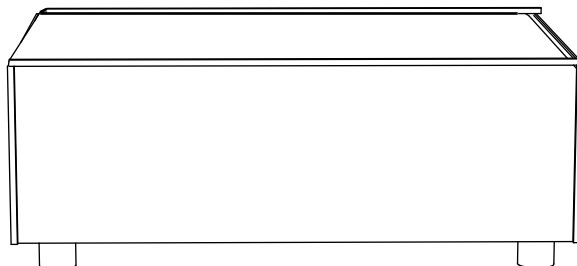

A

x4

B

x4

RESERVE

x 1

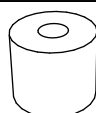
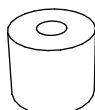
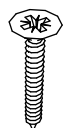

1

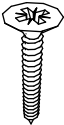
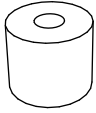
	
A x4	B x4

