

# COUNTRY PÓLKA

W211-311-100007 /010-050-009

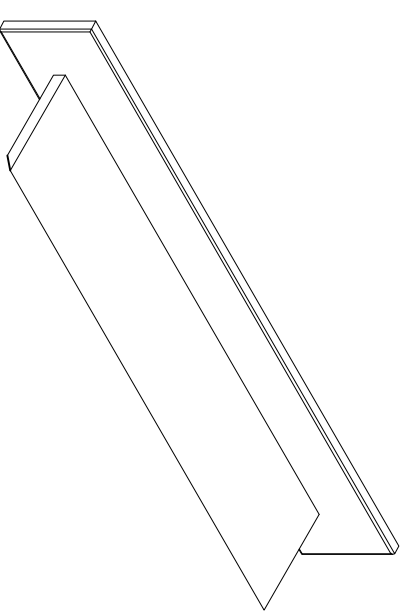

- |   |                                     |
|---|-------------------------------------|
| <b>(D)</b> Montageanleitung             | <b>(GB)</b> Assembly instructions   |
| <b>(FR)</b> Notice de montage           | <b>(IT)</b> Istruzioni di montaggio |
| <b>(NL)</b> Handleiding voor de montage | <b>(PL)</b> Instrukcja montażu      |
| <b>(CZ)</b> Montážní návod              | <b>(SK)</b> Návod na montáž         |
| <b>(HU)</b> Szerelési útmutató          | <b>(RO)</b> Instrucțiuni de montaj  |
| <b>(TR)</b> Montaj talimatı             | <b>(RU)</b> Инструкции по монтажу   |



26.10.2023

**Ostrzeżenie!** Nie pozostawiać dzieci bez opieki w pobliżu mebli podczas montażu.  
Male części, niebezpieczeństwo uduszenia.

**Warning!** Do not leave children unattended near furniture during installation. Small parts, the danger of suffocation.

**Achtung!** Lassen Sie Kinder nicht unbeaufsichtigt in der Nähe von Möbel während der Installation. Kleine Teile, die Gefahr des Ersticken.



**Attention!** Ne laissez pas les enfants sans surveillance à proximité des meubles lors de leur montage. Les petites pièces peuvent présenter un risque de suffocation.

**Opozorilo!** Otroka ne puščajte brez nadzora staršev med montažo.

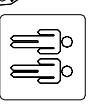
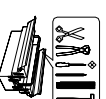
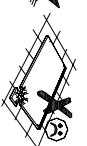
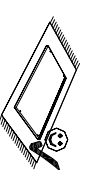
**Upozorenie!** Dijete ne puštajte bez nadzora roditelja tijekom montaže.

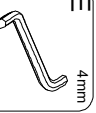

0,5 - 1

- A 8x35 x2
- B  x3
- C  x2
- D  3x13 x4
- E  4mm x1

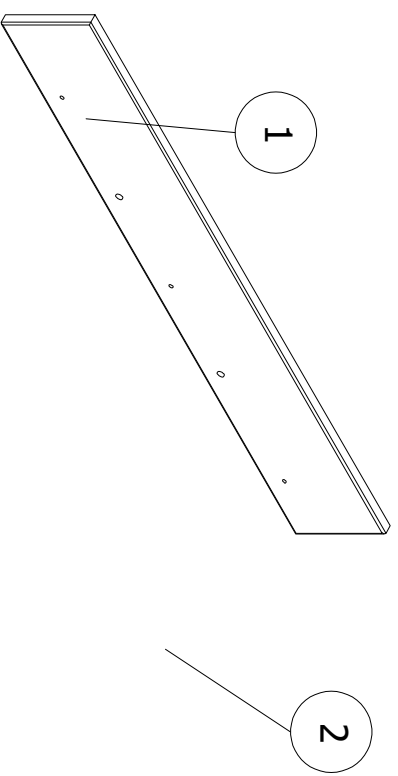

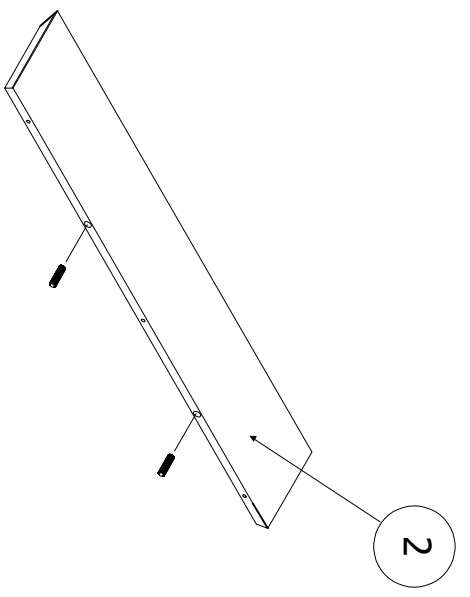

2

- A  8x35 x2



3

- C  x2
- D  3x13 x4

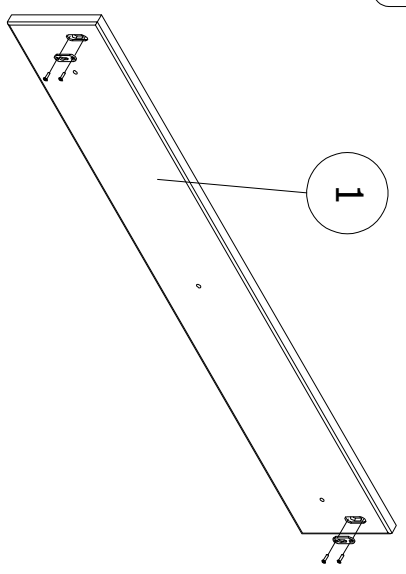

4

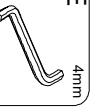
- B  x3
- E  4mm x1

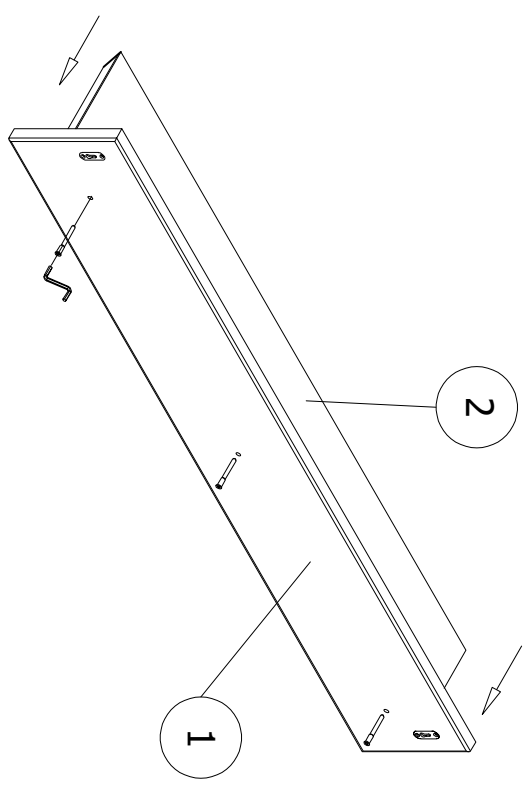

5